

SHARP®

VCR/DVD COMBINATION

錄影機/DVD影碟機 二合一

MODEL 型號

DV-NC70W

香港電器安全規格
(國際電工委員會規格適合)

DV-NC70

DV-NC70X

OPERATION MANUAL 使用說明書



ENGLISH GB 1 - GB 104
中 文 C 1 - C 104

- This Operation Manual explains operation for three models (DV-NC70W, DV-NC70 and DV-NC70X) available in the two geographic areas listed below. Take care to make sure that the instructions you read are for your particular area.
 1. DV-NC70W, DV-NC70 Hong Kong: Region Number 3
 2. DV-NC70X Australia: Region Number 4
- 根據下述兩個地理區域所使用的機型不同，本使用說明書對三種型號的數碼影碟機 (DV-NC70W, DV-NC70 和 DV-NC70X) 的操作進行說明。請注意確認您閱讀的內容是否為針對您所在地區編寫的。
 1. DV-NC70W, DV-NC70..... 香港：區域號 3
 2. DV-NC70X 澳洲：區域號 4

VHS HQ HIGH QUALITY
PAL NTSC

G-CODE® Only for DV-NC70W











NTSC/PAL



About This Manual

- All mentions of "the Remote" refer to the remote control unit.
- The following table describes the icons used in this Operation Manual.

Icon	Meaning
	Tips and Hints for easier operation
	Functions for DVD
	Functions for VIDEO CD
	Functions for Audio CD
	GENERAL INFORMATION
	CONNECTION AND INITIAL SETTING
	VCR, DVD SETUP
	WATCHING THE VCR, DVD
	OTHER INFORMATION

Important!

Be sure to read this Operation Manual carefully before using the Product for the first time, and keep it on hand for future reference when you experience operational problems.

SAFETY INFORMATION

<Only for DV-NC70W/70>

Note:

This Product can be used only where the power supply is AC 110V-240V, 50/60Hz. It cannot be used elsewhere.

<Only for DV-NC70X>

Note:

This Product can be used only where the power supply is AC 240V, 50Hz. It cannot be used elsewhere.

CAUTION:

USE OF CONTROLS OR ADJUSTMENTS OR PERFORMANCE OF PROCEDURES OTHER THAN THOSE SPECIFIED HEREIN MAY RESULT IN HAZARDOUS RADIATION EXPOSURE.

AS THE LASER BEAM USED IN THIS PRODUCT IS HARMFUL TO THE EYES, DO NOT ATTEMPT TO DISASSEMBLE THE CABINET. REFER SERVICING TO QUALIFIED PERSONNEL ONLY.

WARNING:

TO REDUCE THE RISK OF FIRE OR ELECTRIC SHOCK, DO NOT EXPOSE THIS EQUIPMENT TO RAIN OR MOISTURE.

TO REDUCE THE RISK OF FIRE OR ELECTRIC SHOCK, AND ANNOYING INTERFERENCE, USE THE RECOMMENDED ACCESSORIES ONLY.

Laser Diode Properties

Material: AlGaInP

Wave length: 650 nm

Emission Duration: Continuous

Laser output: Max. 0.7 mW

Power Cord Protection

To avoid any malfunctions of the Product, and to protect against electric shock, fire or personal injury, please observe the following.

- Hold the plug firmly when connecting or disconnecting the AC power cord.
- Keep the AC power cord away from heating appliances.
- Never put any heavy object on the AC power cord.
- Do not attempt to repair or reconstruct the AC power cord in any way.

- This Product is classified as a CLASS 1 LASER product.
- The CLASS 1 LASER PRODUCT label is located on the rear cover.
- This product contains a low power laser device. To ensure continued safety do not remove any cover or attempt to gain access to the inside of the product. Refer all servicing to qualified personnel.

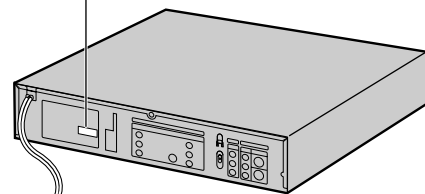

(Rear of product)

SA005WJ



ここを開くとレーザー光が出ます。レーザー光をのぞきまなしないでください。光学機器で直接ビームを見ないでください。

CAUTION-LASER RADIATION WHEN OPEN. DO NOT STARE INTO BEAM OR VIEW DIRECTLY WITH OPTICAL INSTRUMENTS.

VORSICHT-LASERSTRAHLUNG, WENN GEÖFFNET. BLICKEN SIE NICHT IN DEN STRAHL UND BETRACHTEN SIE DIESEN NICHT DIREKT MIT OPTISCHEN INSTRUMENTEN.

ATTENTION-RADIATION LASER EN CAS D'OUVERTURE. NE PAS FIXER LE FAISCEAU NI REGARDER DIRECTEMENT DES INSTRUMENTS OPTIQUES.

VARNING-LASERSTRÅLNING NÄR DENNA DEL ÄR ÖPPNAD. STIRRA EJ IN I STRÅLEN OCH BETRÄKTA EJ STRÅLEN MED OPTISKA INSTRUMENT.

VARO! AVATTAESSA OLET ALTTIINA LASERSÄTELYLLE. ÄLÄ TUJOTA SÄTEESEEN ÄLÄKÄ KATSO SITA OPTISEN LAITTEEN LAPPI.

VARNING-LASERSTRÅLNING NÄR DENNA DEL ÄR ÖPPNAD. STIRRA EJ IN I STRÅLEN OCH BETRÄKTA EJ STRÅLEN GEMON OPTISKT INSTRUMENT.

ADVARSEL-LASERSTRÅLING NÄR DEKSEL ÅPNES. STIRR IKKE INN I STRÅLEN ELLER SE DIREKTE MED OPTISKE INSTRUMENTER.

ADVARSEL-LASERSTRÅLING VED ÅBNING. SE IKKE IND I STRÅLEN-HELLER IKKE MED OPTISKE INSTRUMENTER.

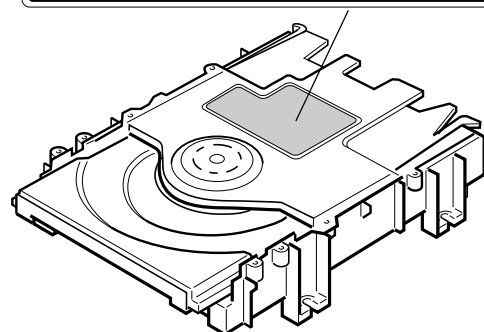

SAFETY INFORMATION

Location and Handling

- Do not place your Product in closed spaces or do not cover it to prevent excessive temperatures inside the Product.
- Do not place the Product in direct sunlight, or near heat sources.
- Keep the Product away from strong magnetic objects.
- Do not place any object containing water or other liquids on the Product. In the event that liquid should enter the cabinet, unplug the Product immediately and contact the retailer or service centre approved by SHARP immediately.
- Do not remove the Product cabinet. Touching parts inside the cabinet could result in electric shock and/or damage to the Product. For service and adjustment inside the cabinet, call a qualified dealer or service centre approved by SHARP.

Nonuse Periods

When the Product is not being used, switch the Product to the standby mode.

When left unused for a long period of time, the Product should be unplugged from the household AC outlet.

No Fingers or Other Objects Inside

Do not put any foreign object on the disc tray.

Stacking

Place the Product in a horizontal position, and do not place anything heavy on it.

Condensation

Moisture may form on the pickup lens in the following conditions:

- immediately after a heater has been turned on.
- in a steamy or very humid room.
- when the Product is suddenly moved from a cold environment to a warm one.

If moisture forms inside this Product, it may not operate properly.

In this case, turn on the power and wait about one hour for the moisture to evaporate.

Cleaning

Unplug your Product before cleaning. Use a damp cloth for cleaning. Do not use cleaning fluids or aerosols which could enter the Product and cause damage, fire, or electrical shock. These substances may also deteriorate the finish of your Product.

If There is Noise Interference on the TV While a Broadcast is being Received

Depending on the reception condition of the TV, interference may appear on the TV monitor when you watch a TV broadcast while the Product is turned on. This is not a malfunction of the Product or the TV. To watch a TV broadcast, turn off the Product.

Service

Do not attempt to service this Product yourself. Please refer any service to the nearest service centre approved by SHARP.

Copyright

Audio-visual material may consist of copyrighted works which must not be recorded without the authority of the owner of the copyright. Please refer to relevant laws in your country.

Copy Protection

This Product supports Macrovision copy protection. On DVDs that include a copy protection code, if the contents of the DVD are copied using a VCR, the copy protection code prevents the videotape copy from playing normally.

Apparatus Claims of U.S. Patent Nos. 4,631,603, 4,577,216, 4,819,098 and 4,907,093 licensed for limited viewing uses only.

This product incorporates copyright protection technology that is protected by method claims of certain U.S. patents and other intellectual property rights owned by Macrovision Corporation and other rights owners. Use of this copyright protection technology must be authorized by Macrovision Corporation, and is intended for home and other limited viewing uses only unless otherwise authorized by Macrovision Corporation. Reverse engineering or disassembly is prohibited.

Recommended Measures for Optimum Picture Excellence



The Product is a precision device that is constructed using extremely accurate technology. Soiling or friction affecting the pickup lens or disc drive can impair the image quality. At the worst, neither video nor audio will be played back. To obtain optimum picture quality, the Product should be checked (cleaning and replacement of some parts) every 1,000 hours. Note that this period varies depending on the environment (temperature, humidity, dust, etc.) in which the Product is used. Contact your authorized Sharp supplier for details.

Do not attempt to clean the pickup lens yourself.



Types of Discs that Can Be Played on This Product

This Product can play back discs bearing any of the following marks:

	<p>DVD DVD-R/DVD-RW* [8cm(3") disc/12cm(5") disc]</p>	<p>See NOTE 1 See NOTE 2 on the next page * Disks that have not been finalized cannot be played back. In addition, disks that have been recorded with the video recording format (VR Recording) also cannot be played back.</p>
	<p>VIDEO CDs [8cm(3") disc/12cm(5") disc]</p>	<ul style="list-style-type: none"> • Supports up to version 2.0.
	<p>Audio CDs [8cm(3") disc/12cm(5") disc]</p>	<p>See NOTE 3 on the next page</p>
<p>CD-R/CD-RW [8cm(3") disc/12cm(5") disc]</p>		<ul style="list-style-type: none"> • Discs recorded in MP3 file format or Audio format.
<p>Other CDs</p> <ol style="list-style-type: none"> 1) On CD-G and CD-EXTRA discs, only the sound can be played (no images). 2) Photo CD, DVD-ROM, DVD-RW (Video Recording Format), DVD-Audio, SACD, SVCD and CD-ROM discs cannot be used. 3) Discs with unusual shapes (heart-shaped or hexagonal discs) cannot be used. The use of such discs will cause a fault. <ul style="list-style-type: none"> • This Product will reject an incompatible disc, therefore the disc type should be checked. 		

This Product will output NTSC signals when playing "NTSC discs".

NTSC signals cannot be converted to modified PAL signals.

An NTSC TV or NTSC-compatible Multi-system TV must be used when playing NTSC discs.

DVD-R/DVD-RW Recording Modes

The video mode refers to a mode that allows playback with an ordinary DVD player. It is the mode that allows recording onto disks of DVD-R Ver. 2.0 or later or DVD-RW Ver. 1.1 or later. The video recording format (VR Recording) refers to the recording mode that allows various recording functions and editing in compliance with the standard specifications of the DVD Forum. (Cannot be played back with this Product)

NOTE 1

- DVD video players and discs are designed with region numbers which dictate the regions in which a disc can be played. If the region number on the disc you want to play does not match the region number in this Product, you will not be able to play the disc.

<Only for DV-NC70W, DV-NC70>

The region number for this Player is 3.

Samples of region number marks compatible with this Player:



Disc playable in all regions

<Only for DV-NC70X>

The region number for this Player is 4.

Samples of region number marks compatible with this Player:



Disc playable in all regions

As for the list of the region number 3, 4 countries and the world map for all region numbers, refer to pages 102 and 103.



Disc Function or Operation that is Not Available

In the cases listed below, the or indicator may appear on the TV screen, which indicates that the function or operation is not available.

- When you intend to perform the function or operation on which the manufacturer restriction is imposed: The specific functions on some DVDs and VIDEO CDs are determined by the disc manufacturer. As this Product plays disc data in accordance with the guidelines of the disc manufacturer, some functions may not be available on some discs. Be sure to read the documentation provided with the disc.
- When you intend to perform the functions or operations prohibited for the current disc: The types of functions and operations that can be used for a particular disc vary depending on the features of that disc. Some disc functions and operations may differ from the descriptions given in this Operation Manual. In this event, follow the instructions given on the screen.

Icons Used on DVDs

Sample Icons

	1. English 2. Chinese		1. English 2. Chinese			
Number of audio tracks		Type of subtitles recorded		Screen aspect ratio recorded	Disc with multiple camera angles	Region code indicator

2

- This Product supports 2-channel (L/R) audio and 5.1ch (Multi-channel) MPEG Audio 1/2 (only when the DIGITAL OUT coaxial jack is used for connection). It does not support 7.1 channel MPEG Audio Version 2.0.

3

- When playing back a CD-G (Graphics) or CD EXTRA disc, the audio portion will be played, but the graphic images will not be shown.

Title, Chapter and Tracks

- DVDs are divided into "titles" and "chapters". If the disc has more than one movie on it, each movie would be a separate "title". "Chapters", on the other hand, are sections of titles.

Example: DVD

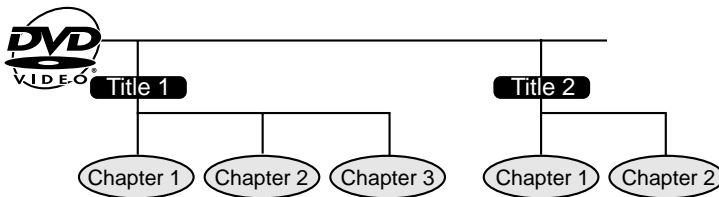

- VIDEO CDs and Audio CDs are divided into "tracks". You can think of a "track" as one tune on an Audio CD.

Example: VIDEO CD or Audio CD



- Numbers identify each title, chapter, and track on a disc. Most discs have these numbers recorded on them, but some do not.



Disc Handling and Maintenance

Handling Precautions

- Hold the disc by the edges so the surface will not be soiled with fingerprints. **(A)**
Fingerprints, dirt and scratches can cause skipping and distortion.
- Do not write on the label side with a ball-point pen or other writing utensils.
- Do not use record cleaning sprays, benzene, thinner, static electricity prevention liquids or any other solvent.
- Be careful not to drop or bend the disc.
- Do not install more than 1 disc on the disc tray.
- Do not try to close the disc tray when the disc is not installed properly. **(B)**
- Be sure to store the disc in its exclusive case when not in use. Then store upright.
- Do not stick paper or adhesive labels to the disc.

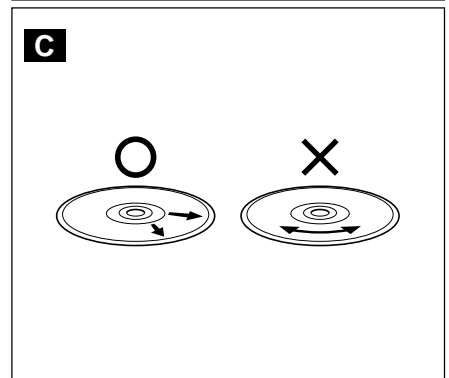
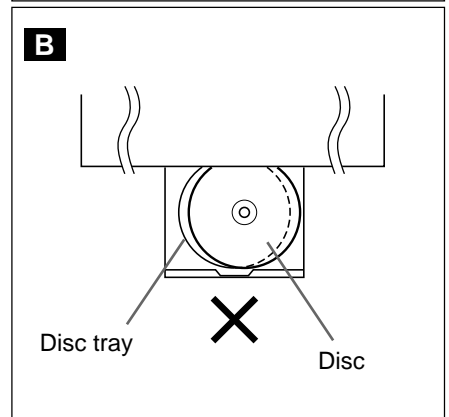
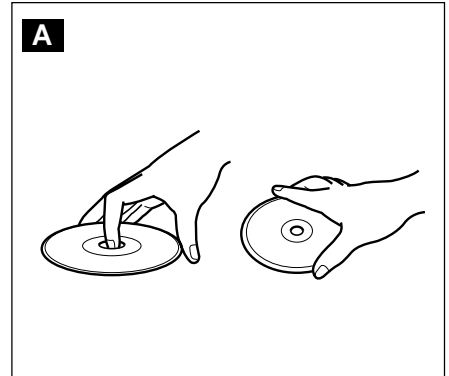

If the Surface is Soiled **(C)**

Wipe gently with a soft, damp (water only) cloth.

When wiping discs, always move the cloth from the center hole towards the outer edge.

(If you wipe the discs using a circular motion, circular scratches are likely to occur, which will cause noise.)

If the playing surface of a disc is soiled or scratched, the Product may decide that the disc is incompatible and eject the disc tray, or it may fail to play the disc correctly. Wipe any soiling off the playing surface with a soft cloth.

If the Disc is Brought from a Cold to a Warm Environment, Dew May Form on the Disc

Wipe the dew off with a soft, dry, lint-free cloth before using the disc.

Improper Disc Storage

You can damage discs if you store them in the following places:

- Areas exposed to direct sunlight
- Humid or dusty areas
- Areas directly exposed to a heat outlet or heating appliance

Maintenance

- Be sure to turn the Product off and disconnect the AC power cord before maintaining the Product.
- Wipe this Product with a dry soft cloth.
If the surfaces are extremely dirty, wipe clean with a cloth which has been dipped in a weak soap-and-water solution and wrung out thoroughly and then wipe again with a dry cloth.
- Never use alcohol, benzene, thinner, cleaning fluid or other chemicals. And do not use compressed air to remove dust.

Contents



GENERAL INFORMATION

SAFETY INFORMATION	1
Types of Discs that Can Be Played on This Product	3
Disc Handling and Maintenance	5
Features	8
Accessories	8
Major Components	9



CONNECTION AND INITIAL SETTINGS

Basic Connection	14
Connecting to ANTENNA IN/RF OUT	14
Connecting a TV Equipped with VIDEO/AUDIO Input Jacks	15
Using the Component Colour (Y, P _B (C _B), and P _R (C _R)) Output Jacks	15
DVD Audio Connections	16
Connecting a TV Equipped with S-VIDEO Input Jacks	16
Connecting to Audio Equipment	16
Playing 2 channel audio	16
Playing Dolby Digital (5.1 channel), DTS or MPEG audio	17
Preparations Before Using the Product	18
Adjusting the Video Channel	19
Auto Tuning System	21



VCR SETUP

VCR Setup	24
Menu Screen	24
Mode Selection	25
Setting the Channels	27
Auto Tuning	28
Manual Tuning	30
Channel Skip/Cancelling Skip	32
Channel Skip	32
Cancelling Skip	34
Setting the Clock	35
Initial Setting of Clock	35
Changing the Clock Setting	36
Setting the Language	37
VCR-RESET	37
Initial Setting of Language	37
Changing Language	37

VCR Display Information	38
How to Display Indicators	38
VCR Front Panel Display	38



DVD SETUP

DVD Setup	40
About the SETUP Screen	40
TV MODE Setting	41
PARENTAL Level Setting	42
AUDIO Setting	44
Setting the COMPRESSION (Dolby Digital output level)	44
Setting the DOLBY DIGITAL	45
Setting the MPEG	46
Setting the CINEMA VOICE	46
DISC LANGUAGE Setting	47
Setting SUBTITLE, AUDIO and MENU languages	47
Selecting languages from OTHER	48
DVD Display Information	49
Operation Mode Indicators	49
Language Code List for Disc Language ...	50



WATCHING THE VCR

Playback	52
Inserting a Video Cassette	52
Playback	52
Video Search (with the Remote)	52
Fast Forwarding and Rewinding	53
Slow Motion Playback (with the Remote)	53
Still Picture and Frame Advance	53
Double Speed Playback	53
NTSC Tape Play Back on PAL TV	54
Full Auto Playback	54
Auto Head Cleaning System	54
Auto Tracking Control System	54
Quick Start with Full Loading Mechanism	54
AUTO RENTAL	55
COLOUR	55
BLUE BACK	56
Playback of Hi-Fi Recorded Tapes	57
Audio Output Mode	57
Adjusting Hi-Fi Audio Tracking	57
Sharp Super Picture	58
Auto Repeat	59
Auto Zero Back	60

DPSS (Digital Program Search System)
/Skip Search 61
 DPSS 61
 Skip Search 61

TV Programme Recording 62
 Cassette Erase Protection 62
 Recording a TV Programme 62
 To Watch Another TV Programme While
 Recording 62
 Recording NICAM/IGR Multiplex Broadcasts ... 63

Simple Recording Timer 64
 Immediate Recording 64

**Programming the Timer with G-CODE® System
 (DV-NC70W only) 65**
 Setting the Programme Number In Step 4 67

Recording with the Timer 68
 Confirming Timer Programmes 71
 Cancelling Timer Programmes 72

Tape Dubbing 73

**Recording a DVD Disc onto a Video
 Cassette 74**
 Recording a DVD disc onto a Video cassette
 (Tape Editing mode) 74



WATCHING THE DVD

Preparing to Use DVD 78
 When connecting a TV with the
 DVD output jacks 78
 When connecting a TV with the
 DVD/VCR shared output jacks 78

Playback 79
 Basic Play 79
 Track Direct Playback 79
 Fast Forward/Fast Reverse 80
 Slow-Motion Play 80
 Still/Pause 81
 Frame Advance 81
 Skip (Forward/Reverse) 81

Angle Selection 82

Playing MP3 Discs 83
 Regarding MP3 discs 83
 Playing MP3 discs 83
 To play MP3 discs 84
 To play another file (music title) while playing .. 84
 To skip the file while playing 84

About the Function Control Screen 85
 Direct skip (title [track]/chapter/time) 86
 Subtitle language setting 87
 Angle setting 88
 Audio setting 89
 3D VIRTUAL SURROUND setting 90
 DIGITAL GAMMA setting 91

Direct Selection of Scenes 92
 Selecting Scenes by Title Number 92
 Selecting Scenes from the Menu Screen 92

Programmed Playback 93
 Chapter Programmed Playback 93
 Track Programmed Playback 94
 MP3 Files Programmed Playback 95

Repeat Playback 96
 Repeat playback 96
 A-B Repeat 97

Resume Function 98



OTHER INFORMATION

Troubleshooting 99
Definition of Terms 101
Specifications 104

GENERAL
INFORMATION

CONNECTION AND
INITIAL SETTINGS

VCR SETUP

DVD SETUP

WATCHING
THE VCR

WATCHING
THE DVD

OTHER
INFORMATION

Features

■ Common Features

- A DVD, AUDIO CD, VIDEO CD player and VCR all in one.
- Simultaneous VCR recording and DVD playback.

■ VCR

- **VHS** Hi-Fi Stereo Sound, NICAM/IGR System
- 380-times High Speed Rewind Function (in NTSC)
- S-VHS Simple Playback
- HQ (High Quality) Circuitry
- Simple Recording Timer
- Sharp Super Picture
- G-CODE System* only for DV-NC70W

* For Hong Kong: G-CODE is a registered trademark of Gemstar Development Corporation. The G-CODE system is manufactured under license from Gemstar Development Corporation.



■ DVD

- Plays DVD, VIDEO CD and Audio CD discs as well as CD-R/CD-RW discs recorded in MP3 file format
- 3D Virtual Surround provides high-quality surround sound
- Digital Gamma correction
- Dolby Digital*¹, DTS*², MPEG Audio digital out capability
- High-quality digital images
- High-quality digital sound



*¹ Manufactured under license from Dolby Laboratories. "Dolby" and the double-D symbol are trademarks of Dolby Laboratories.

*² "DTS" and "DTS Digital Surround" are trademarks of Digital Theater Systems, Inc.

Disc Features and this Operation Manual

- The types of functions and operations that can be used for a particular disc vary depending on the features of that disc. In some cases, these functions and operations may differ from the descriptions given in this Operation Manual. In this event, follow the instructions given on the screen. This Operation Manual only covers basic disc operations.
- **For some operations, the  or  indicator may appear on the TV screen. This indicates that the operation described in this Operation Manual is not permitted for the current disc.**

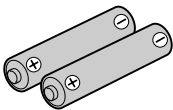
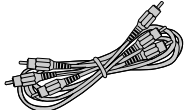
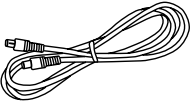
Accessories

 <p>Remote control unit</p> <div data-bbox="444 1329 620 1421"> <table border="1"> <tr> <td>DV-NC70W</td> <td>.....</td> <td>G-CODE</td> </tr> <tr> <td>DV-NC70</td> <td>.....</td> <td>PROG</td> </tr> <tr> <td>DV-NC70X</td> <td></td> <td></td> </tr> </table> </div>	DV-NC70W	G-CODE	DV-NC70	PROG	DV-NC70X			 <p>Two batteries (AA, R6 or UM/SUM-3) for the Remote</p>	 <p>VIDEO/AUDIO cable</p>
DV-NC70W	G-CODE									
DV-NC70	PROG									
DV-NC70X											
	 <p>RF cable</p>	 <p>Operation Manual</p>									

Major Components

VCR Main Unit (Front)

Numbers in **■** refer to the main pages in this Operation Manual where the topic is explained.

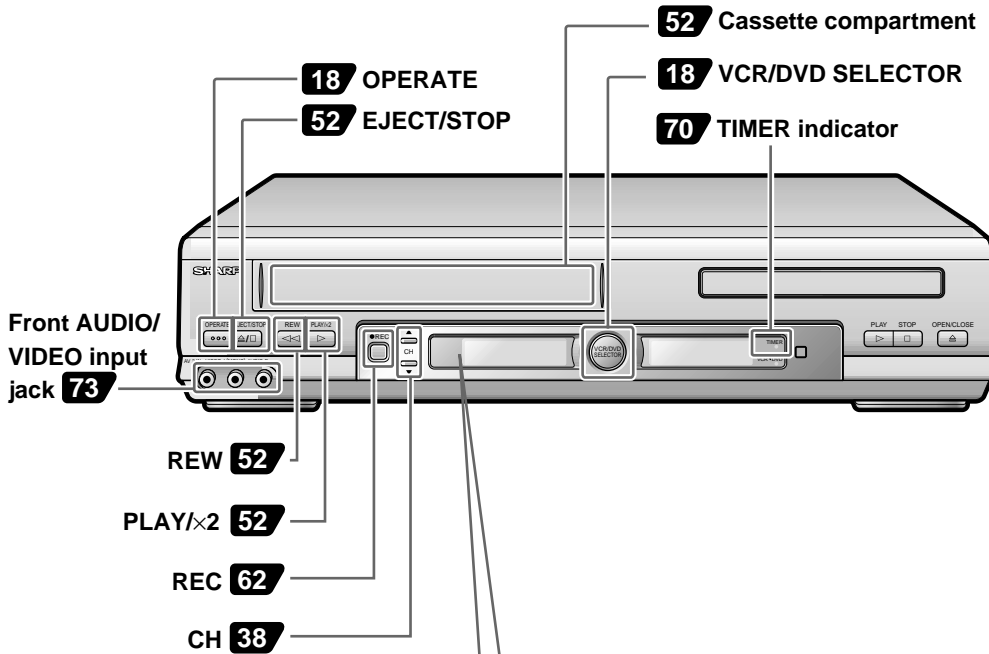

VCR Front Panel Display

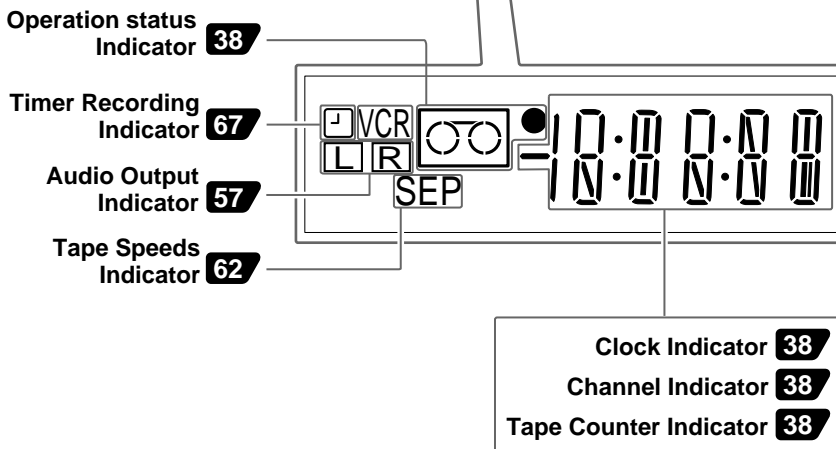



DVD Main Unit (Front)

Numbers in  refer to the main pages in this Operation Manual where the topic is explained.

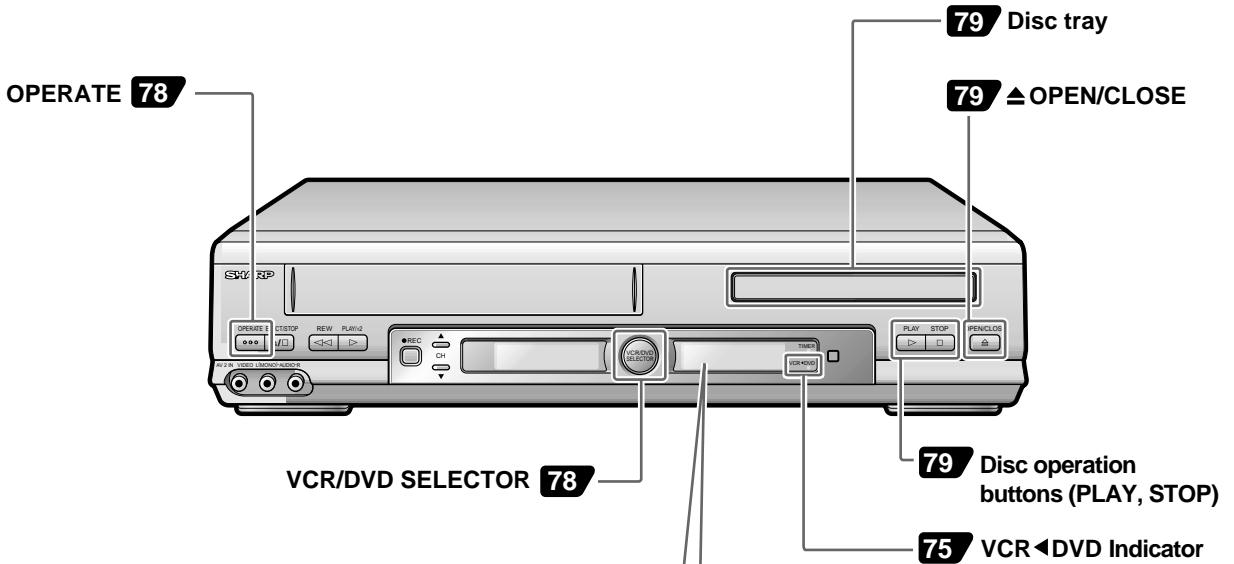

DVD Front Panel Display

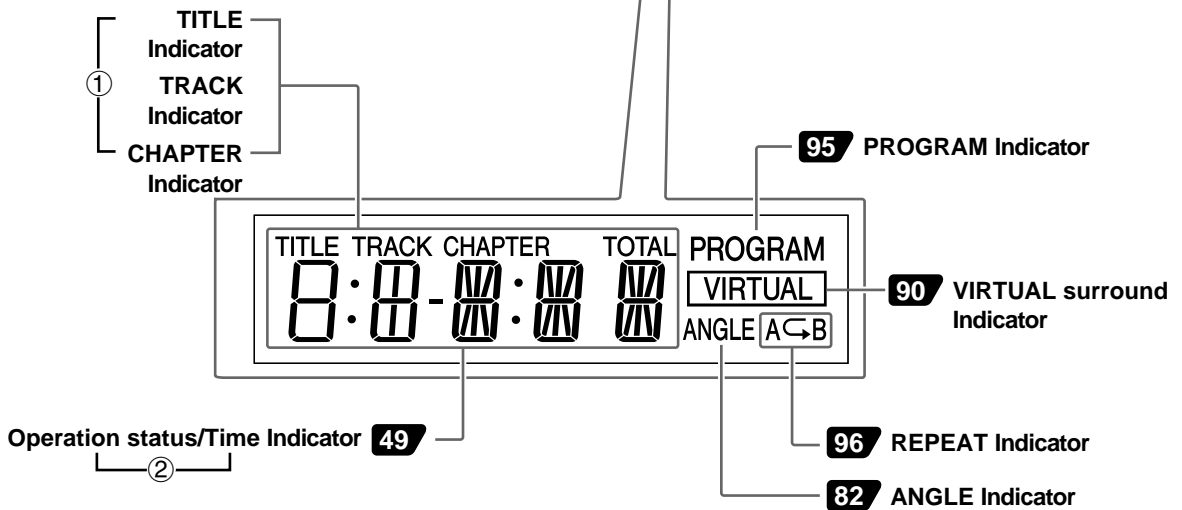

You can toggle between ① and ② by pressing the remote control unit's **DISPLAY** button (page 49).



Remote (VCR Operation Buttons)

- The explanations on this page use the **VCR/DVD CHANGE Switch** in the **VCR** position.

Numbers in  refer to the main pages in this Operation Manual where the topic is explained.

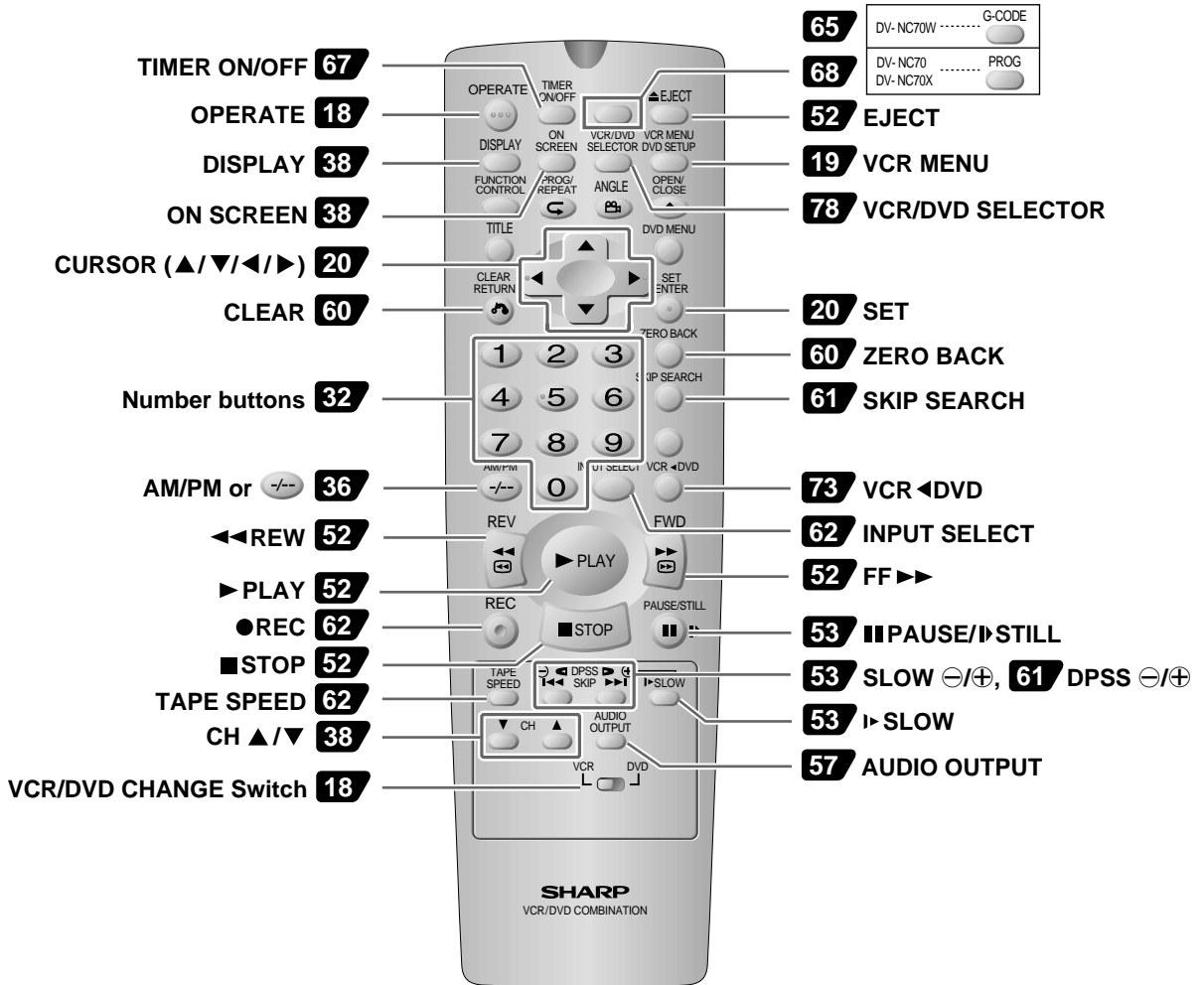

Loading the Batteries

- Open the battery cover by pulling the lid in the direction of the arrow.

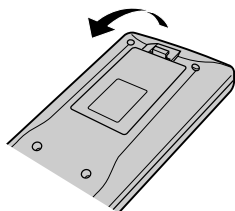

- Load the batteries. Load the two batteries (AA, R6 or UM/SUM-3) supplied with the Remote so that the battery poles ⊕ and ⊖ are positioned as indicated.

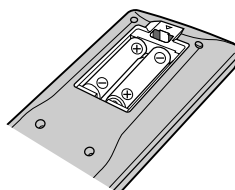

- Close the battery cover by lowering the lid in the direction of the arrow.

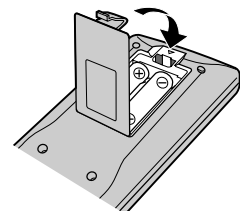



Remote (DVD Operation Buttons)

- The explanations on this page use the **VCR/DVD CHANGE Switch** in the **DVD** position.

Numbers in **[]** refer to the main pages in this Operation Manual where the topic is explained.



NOTE

- Do not subject the Remote to shock, water or excessive humidity.
- The Remote may not function if the Product sensor is in direct sunlight or any other strong light.
- Incorrect use of batteries may cause them to leak or burst. Read the battery warnings and use the batteries properly.
- Do not mix old and new batteries, or mix brands in use.
- Remove the batteries if you do not use the Remote for an extended period of time.



Main Unit (Rear)

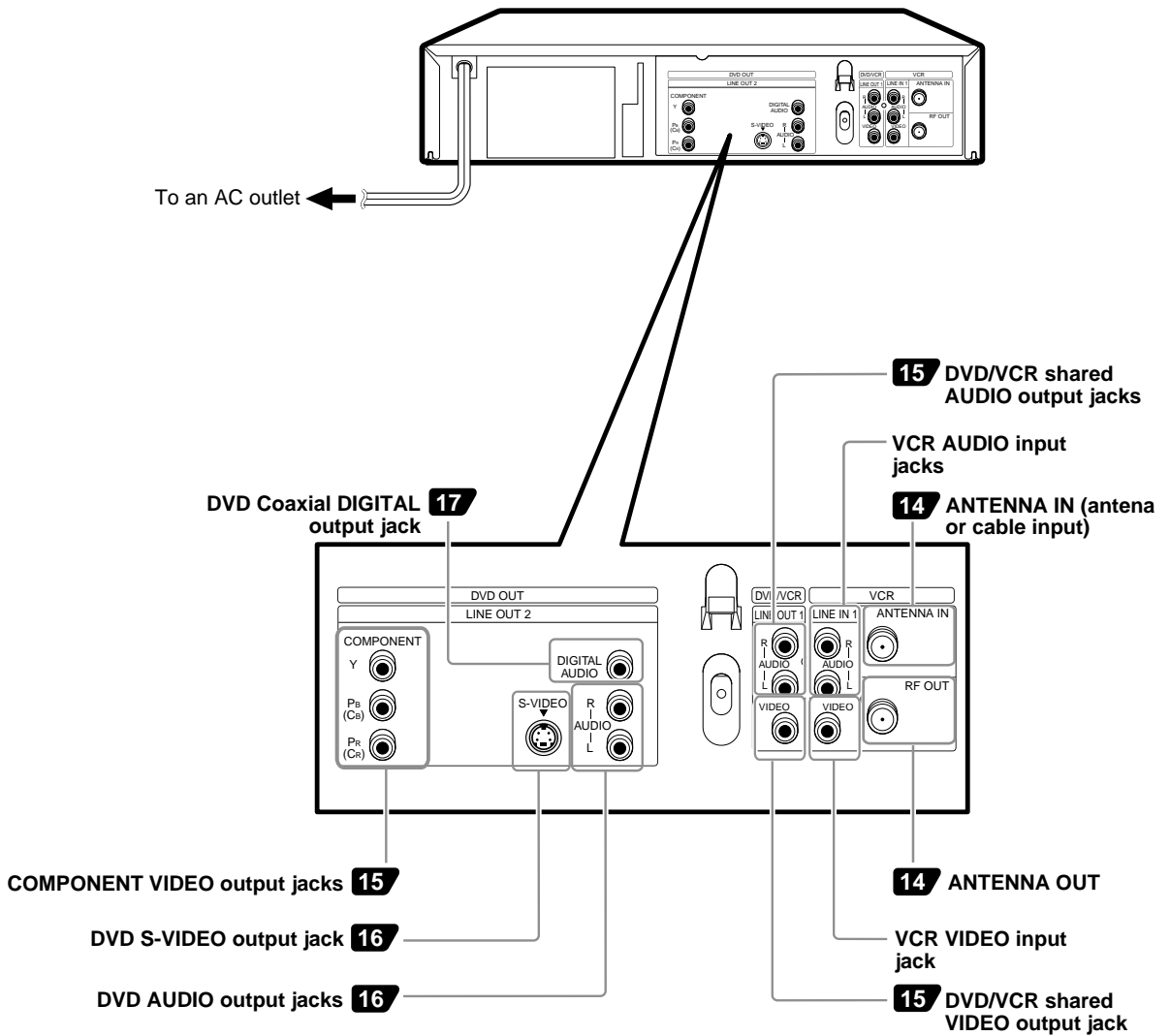



Basic Connection

! Caution:

- Be sure to turn off the Product and equipment to be connected before connecting.
- Read through the operation manual for the equipment to be connected.
- Be sure that the colours of the jacks and plugs match up when using a VIDEO/AUDIO cable.
- Be sure to keep the Product connection cables separate from the TV antenna cable when you install the Product, because it may cause electrical interference when you are watching television programmes.

Connecting to ANTENNA IN/RF OUT

The connection method differs depending on the type of TV.

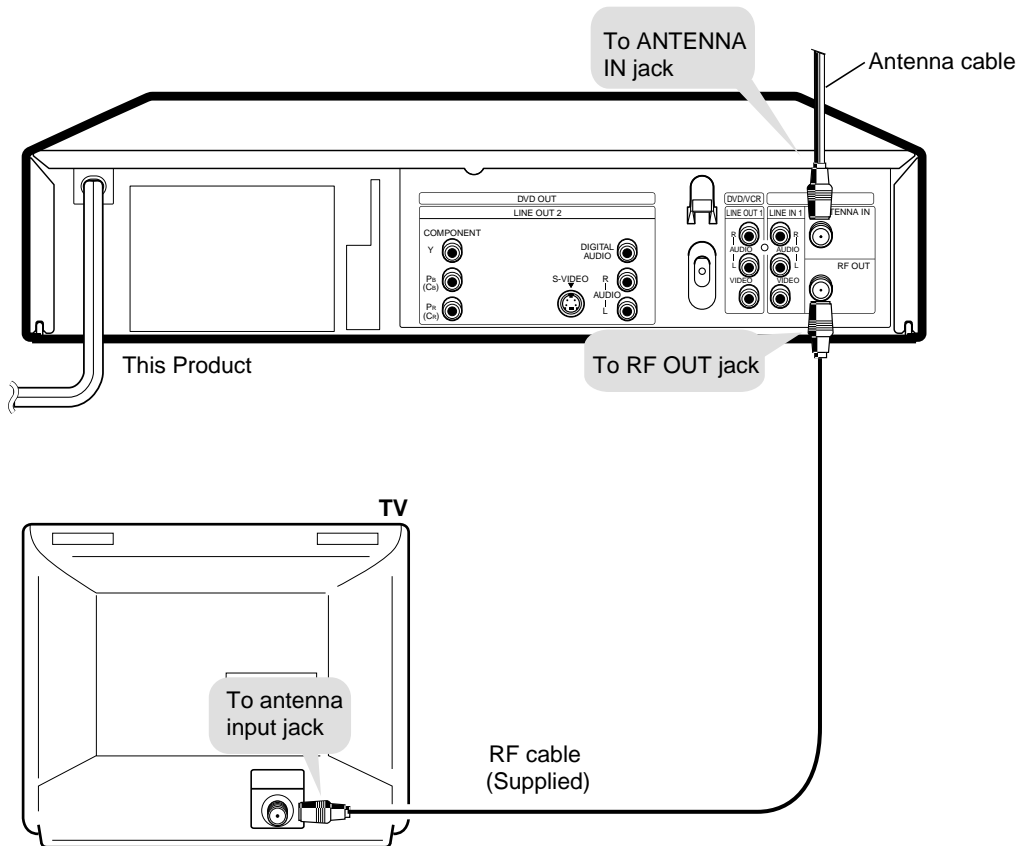



Connecting a TV Equipped with VIDEO/AUDIO Input Jacks

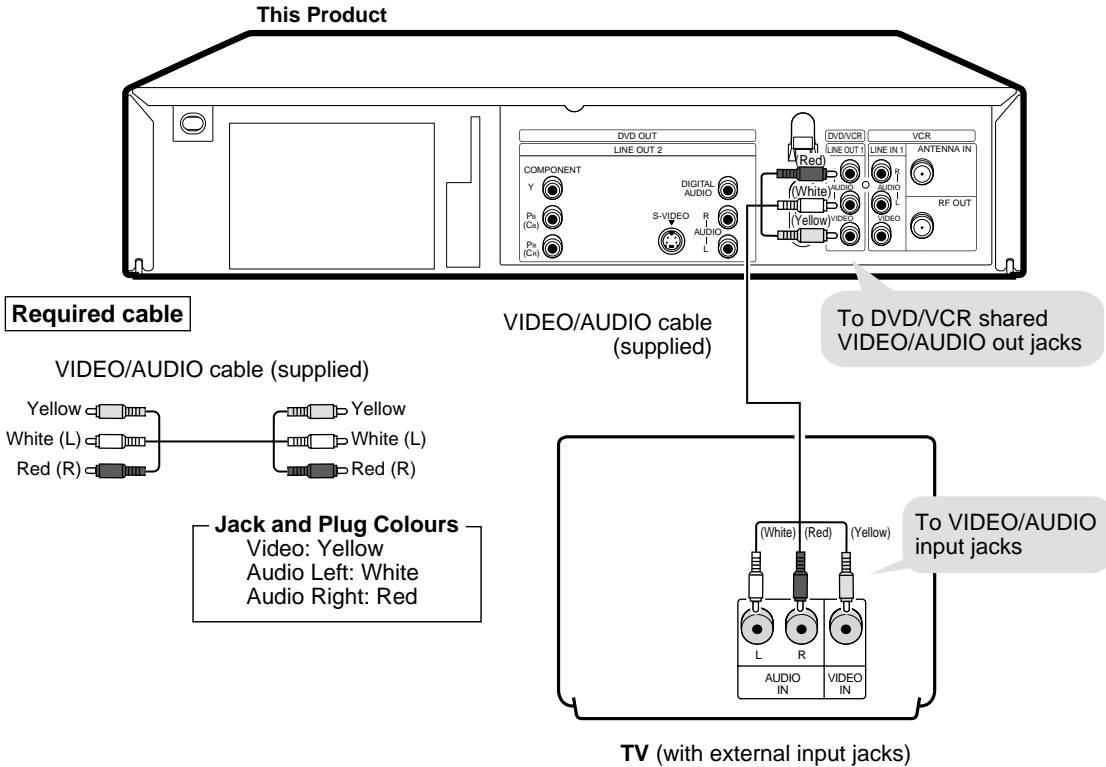

You will not be able to hear all of the sound being output by the Product if you use the supplied VIDEO/AUDIO cable to a monaural TV that has only one AUDIO input jack.

NOTE

- Make sure that colours of the jacks and plugs match up when connecting the cable.
- Connect the Product directly to the TV. If you attempt to view video on a TV connected via a VCR, the copy protection function will scramble the picture.
- If you want to listen to the audio through audio equipment, connect only the VIDEO cable to the TV.

Using the Component Colour (Y, P_B (C_B) and P_R (C_R)) Output Jacks

Colour Output Jacks (Y, P_B (C_B) and P_R (C_R)):

Some TVs and monitors are equipped with input jacks for the component colour signals (Y, P_B (C_B) and P_R (C_R)). By connecting these input jacks to the corresponding output jacks on the Product, you can enjoy higher quality playback images. If you are using a TV or monitor equipped with Y, P_B (C_B) and P_R (C_R) jacks, use these jacks rather than the S-VIDEO OUT jack.

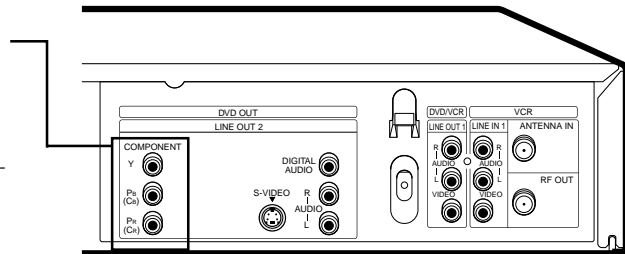



DVD Audio Connections

Connecting a TV Equipped with S-VIDEO Input Jacks

When you want to achieve a better video image by connecting a TV equipped with an S-VIDEO input connector to the Product, you should use an S-VIDEO cable (commercially available) to connect the TV to the Product.

Connecting to Audio Equipment

Connecting the Product to audio equipment provides normal stereo sound plus powerful stereo sound enhanced by Dolby Digital (5.1 channel), DTS, and MPEG Audio.

Playing 2 channel audio

■ Analogue Connection

Required cables

AUDIO cable (commercially available)

White (L)

Red (R)

S-VIDEO cable (commercially available)

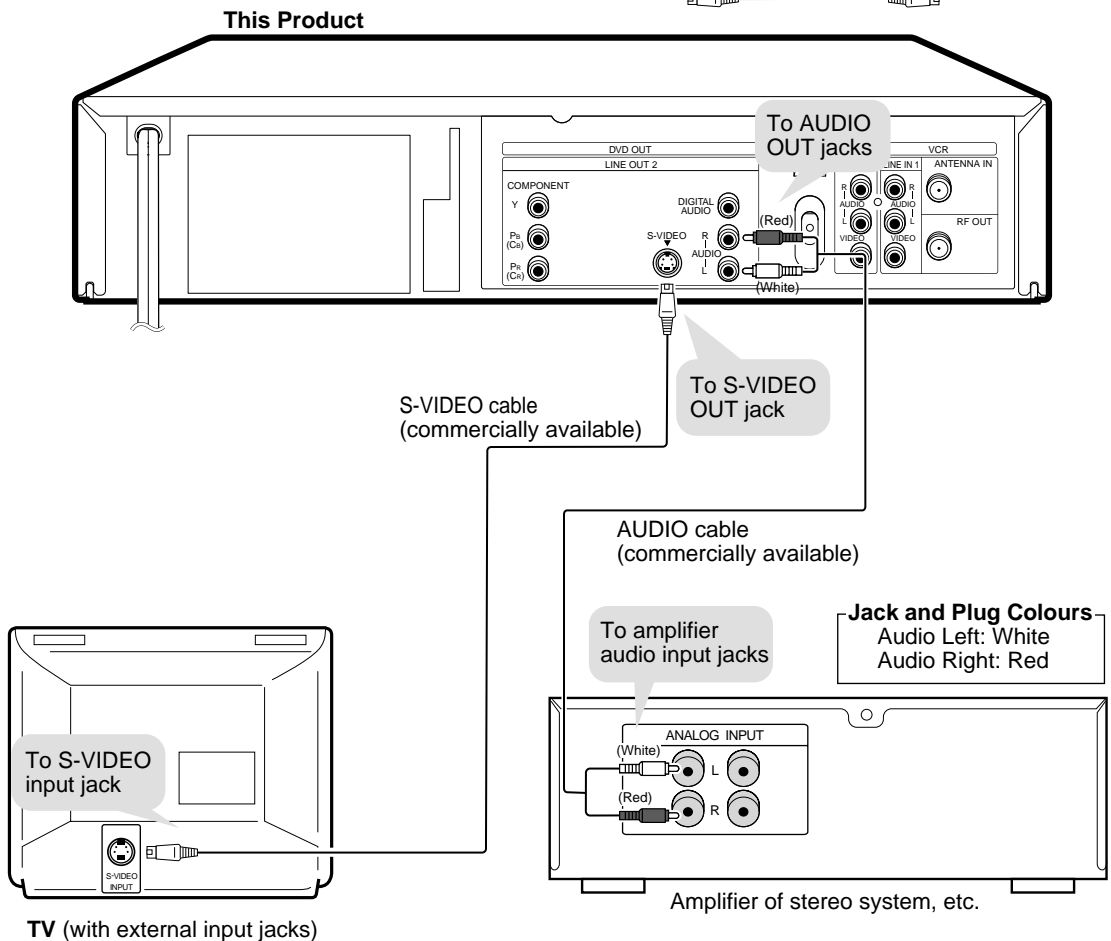

If the Product is set to OPERATE ON, the DVD signals will be output from the DVD OUT jacks at all times. (The DVD signals will be output from the DVD OUT jacks also when using the VCR.)



Playing Dolby Digital (5.1 channel), DTS or MPEG audio

Connecting an amplifier with a Dolby Digital/DTS/MPEG Audio digital surround processor or a Dolby Digital/DTS/MPEG Audio surround processor to your Product's coaxial digital jack provides richer and more powerful audio play.

■ Connection to a processor or amplifier with a coaxial digital input jack

You can make this connection using a coaxial digital cable.

Required cable

Coaxial digital cable (commercially available)

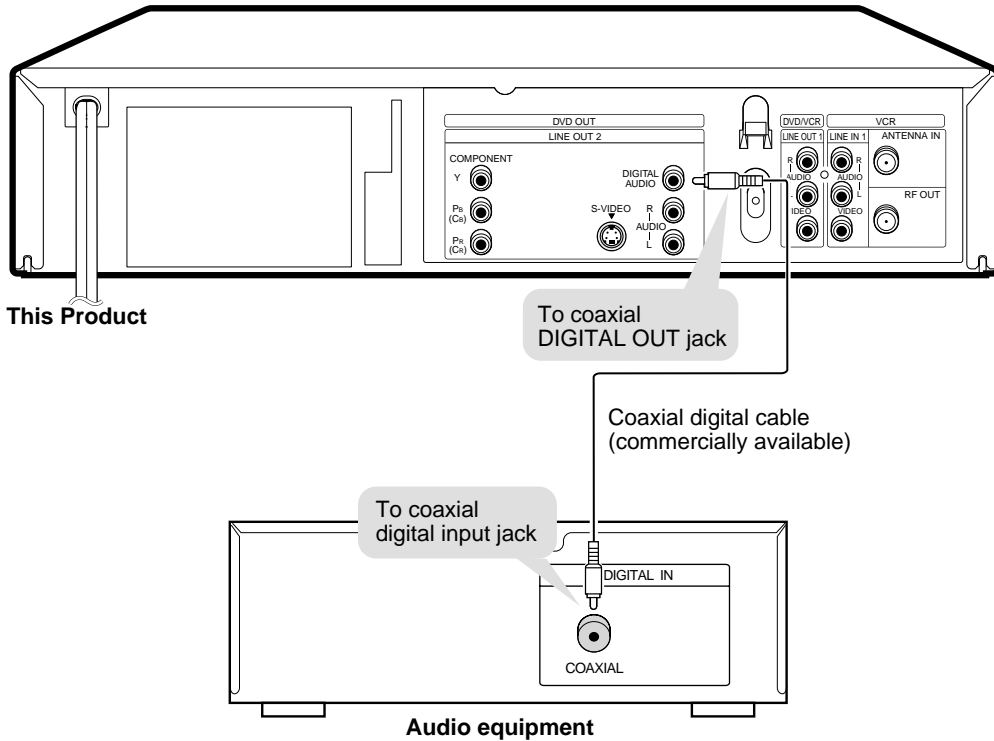
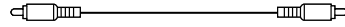

■ Digital Connection to an MD to Record a CD

Some Audio CDs and VIDEO CDs have a short silent section between musical tracks. When sound from discs such as these is digitally recorded by connecting the Product directly to a digital recorder (such as an MD player), the music may be recorded continuously and track numbers may be lost.

■ Digital Connection to Audio Equipment or MD Player without a Dolby Digital Decoder

- Audio CD or VIDEO CD
Play the disc as you normally would, with the audio mode set to "L+R" (see page 89). With a digital connection, audio of a disc recorded with DTS sounds abnormal in this case.
- DVD
With a digital connection, audio cannot be produced from a DVD recorded with Dolby Digital (5.1 channel), Dolby Surround (Pro Logic), DTS or MPEG Audio, so you should use an analogue connection to play such discs. Discs with linear PCM audio should play normally.

NOTE

- This connection is not possible if the processor or amplifier to which you want to connect does not have a coaxial digital input jack.



Preparations Before Using the Product

Preparing to Watch a VCR or a DVD

- 1 Turn on the TV and switch the TV channel to the external "VIDEO" or "AV" channel connected to the DVD/VCR shared output jacks.
- 2 Press **OPERATE**.
 - The product is turned on.
- 3 Press **VCR/DVD SELECTOR** on the remote control to switch to the "VCR" mode or "DVD" mode.
 - The VCR/DVD SELECTOR on the product lights up in orange for "VCR" or green for "DVD".

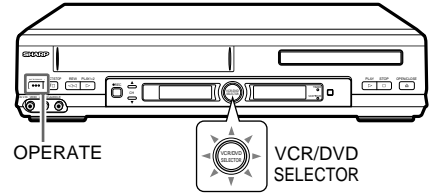

- Each time **VCR/DVD SELECTOR** is pressed, the mode changes between "VCR" mode and "DVD" mode.
- The mode can be switched by pressing the **VCR/DVD SELECTOR** on the product.

- 4 Move the **VCR/DVD CHANGE Switch** on the Remote to either "VCR" or "DVD".

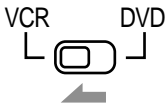

The VCR functions on the Remote will now take priority.

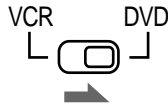

The DVD functions on the Remote will now take priority.





Adjusting the Video Channel

To view the output of your Product on the television screen, you must select an unused channel on your TV and tune it to the output of your Product (see Table 1 for factory preset to UHF Channel).

- 1 Make sure both Products (TV and this Product) are connected (power cord) to the power outlet.
- 2 Turn on your TV.
- 3 Select an unused channel on your TV.
- 4 Set the power on the Product to off. (If the Product is ON, press **OPERATE** to turn off the power.)
- 5 Keep pressing **VCR MENU** for more than two seconds to light up the UHF Channel (see Table 1) on the VCR Front Panel display.

Table 1

		Factory Preset UHF Channel
Ex.	South East Asia, Hong Kong	60
	Australia	37

- 6 Adjust the tuning of the selected TV channel until the RF pattern appears on your TV screen. (Refer to your Operation Manual for tuning procedures.)

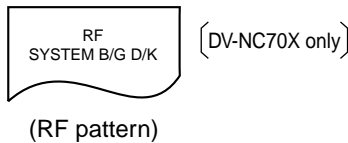
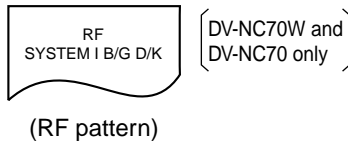



7 Press ◀/▶ to select the RF output system that corresponds to your TV by referring to the chart shown to the below, and press **SET**.

		I, B/G, D/K (RF system)
Ex.	Hong Kong	I
	China, Russia	D/K
	South East Asia	B/G
	Australia New Zealand	

8 Press **OPERATE** to turn on the power of the Product. Select any channel on the VCR tuner. If a picture appears and sound can be heard, then the RF output system is correctly set. If a picture appears but no sound can be heard, then perform step 7 above to select another RF output system.

NOTE

- Make sure the sound is not muted when checking the RF output system.
- It is not necessary to change the system to RF system "M". The Product will automatically detect and change the RF system to "M" when receiving the NTSC signal.
- If picture interference appears on the TV screen in step 6 above, you can change the video channel (RF output channel from the Product to TV) with the following procedure. If UHF Channel (see Table 1) is an active broadcast channel in your area, manually select a different channel (UHF 21 to UHF 69) (see below) and then retune your TV as above.
 - 1 Press **OPERATE** to turn off the power.
 - 2 Keep pressing **VCR MENU** for more than two seconds to light up the UHF Channel (see Table 1) on the VCR Front Panel display.
 - 3 Press ▲ / ▼ on the Remote to manually select an unused channel for use as the video channel.
 - 4 Perform steps 6 to 7 above using the newly selected video channel.
 - 5 Repeat steps 3–4 to select the optimal video channel.



Auto Tuning System

This Product is equipped with an Auto Tuning System to provide easier set up of the Product. After following the instructions for "Basic Connection" on pages 14 and 15 and "Adjusting the Video Channel" on page 19, turn on your TV, press **OPERATE** to turn on the Product, and select the video channel. The Product will automatically display the setting screens as shown below.

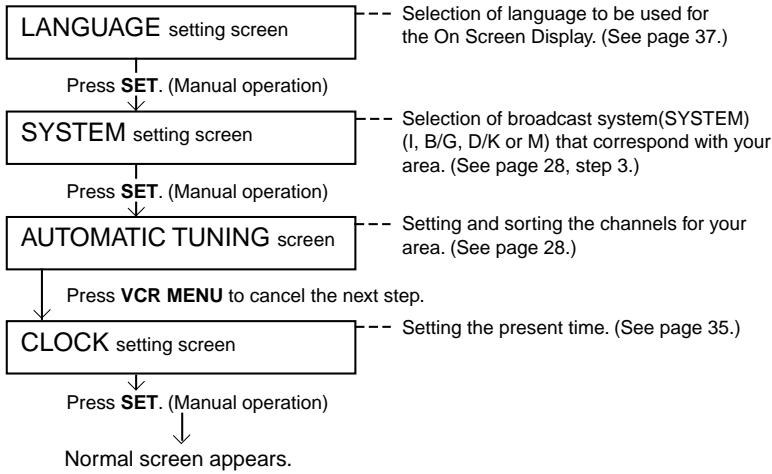

DV- NC70W	G-CODE
DV- NC70	PROG
DV- NC70X	



NOTE

- If the Language selection and Auto Tuning have already been performed, the Clock setting screen will first appear. To reset all VCR settings and perform the Auto Tuning from the Language setting screen, see page 37. (Perform "VCR-RESET")

VCR Setup

VCR Setup	24
Menu Screen	24
Mode Selection	25
Setting the Channels	27
Auto Tuning	28
Manual Tuning	30
Channel Skip/Cancelling Skip	32
Channel Skip	32
Cancelling Skip	34
Setting the Clock	35
Initial Setting of Clock	35
Changing the Clock Setting	36
Setting the Language	37
VCR-RESET	37
Initial Setting of Language	37
Changing Language	37
VCR Display Information	38
How to Display Indicators	38
VCR Front Panel Display	38

Menu Screen

The menu screen is a home screen used to select various screen functions. A sub-menu will appear once you select an item for the menu. See the following pages for details on each menu procedure.

NOTE

- The word "G-CODE" will only appear on menu screen for DV-NC70W which has the G-CODE system.

Menu Screen

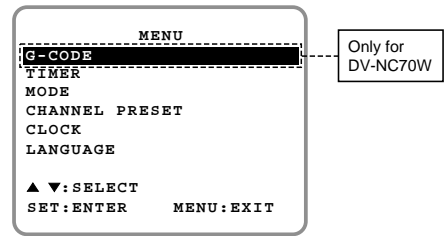

MENU item list

Main Menu

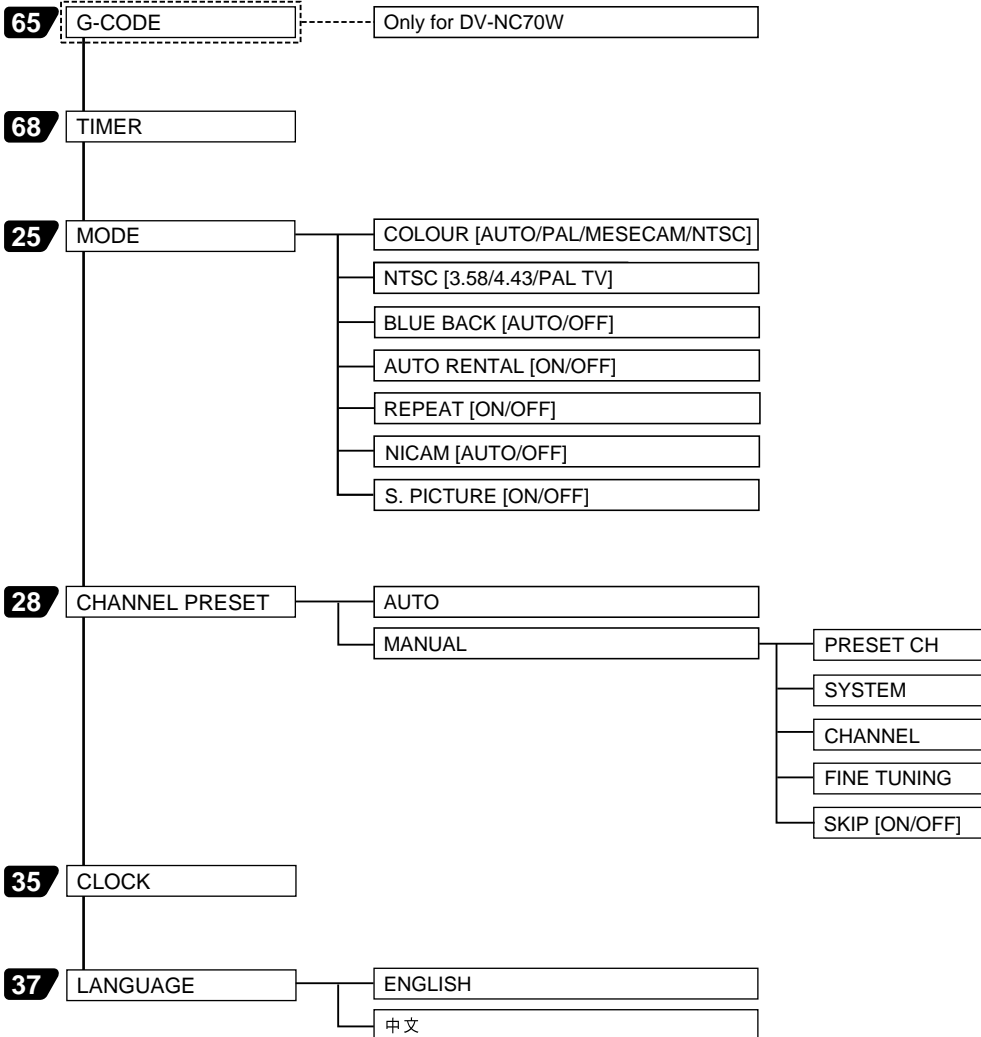

- Numbers in refer to the pages where the setting procedures are described.



Mode Selection

You can set the basic functions listed in the table below on the MODE selection screen.

Preparation

- Press **OPERATE**. Then move the **VCR/DVD CHANGE Switch** to **VCR**.

- 1 Press **VCR MENU** to display the menu screen.
- 2 Select "MODE" with ▲ / ▼ and then press **SET** to confirm.

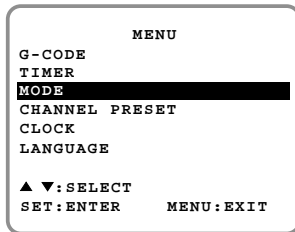

- 3 Set "NTSC" to "3.58", "4.43" or "PAL TV" with ◀/▶. Then press ▼.

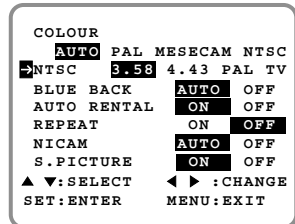

- NTSC 3.58** When using NTSC 3.58 TV system.
(Input signal: NTSC 3.58)
- NTSC 4.43** When using NTSC 4.43 TV system.
(Input signal: NTSC 4.43)
- PAL TV**..... When using PAL TV system.
(Input signal: NTSC 4.43)

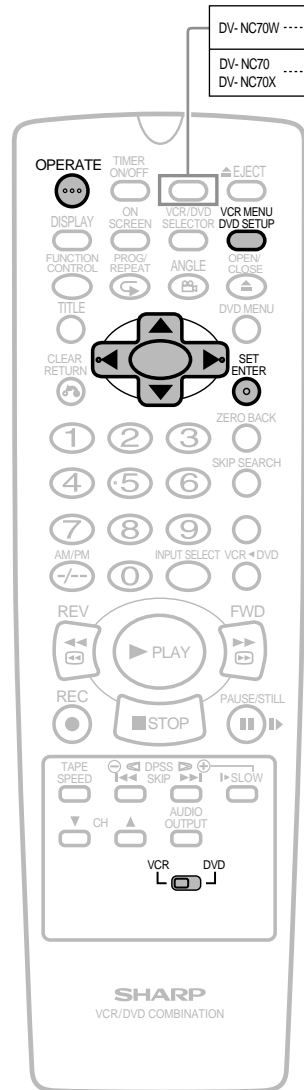



4 Set "NICAM" to "AUTO" or "OFF" with ◀/▶. Then press ▼.

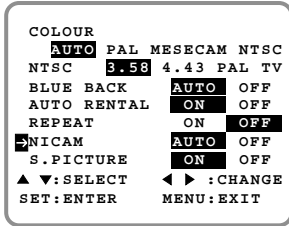

AUTO..... Usually select "AUTO".

OFF..... Select "OFF" when your TV does not have good NICAM signal reception and a lot of noise is heard when the AUTO mode is set. (Selecting "OFF" will change it to normal audio signal reception.)

- You can change the COLOUR, BLUE BACK, AUTO RENTAL, REPEAT and S.PICTURE settings the same way (See pages 55, 56, 58 and 59).

5 Press **SET** to enter.

- The screen returns to normal.

NOTE

- If you press **VCR MENU** to exit the mode selection screen in Step 4, the data will not be stored. Be sure to press **SET** to store the data.





Setting the Channels

Your Product can receive VHF channels 1A to E12 (US AIR 2 to 13), CATV/HYPER channels S1 to S41 and UHF channels E21 to E69 (US AIR 14 to 78). Your Product has 84 programmable channel positions, each of which can be set to any of the broadcast and CATV/HYPER channels.

- Channel positions 13 through 83 will not be displayed when selected. These channel positions have been set at the factory to be skipped.
- To view a skipped channel position, tune that position to a broadcast CATV/HYPER channel, or cancel the channel skip function for that position.

VCR CHANNEL	BROADCAST TV CHANNEL				
	SOUTH EAST ASIA	CHINA	CATV	AUSTRALIA	NEW ZEALAND
000				0	01
001	1A			01	01
002	F-2			02	02
003	F-3	C-1		02	02
004	F-4	C-2	02	03	03
005	F-5	C-3	03	04	04
006	F-6	C-7	07	05	05
007	F-7	C-8	08	06	06
008	F-8	C-9	09	07	07
009	F-9			10	08
010	F-10	C-10	12	09	09
011	F-11	C-11	13	10	10
012	F-12	C-12	23	11	
	F-12	Z-8	24		
021	E-21	C-13		28	
022	F-22	C-14	67		
023	F-23	C-15	68		
024	F-24	C-16	69		
025	F-25	C-17	71		
026	F-26	C-18	72		
027	F-27	C-19	73		
028	F-28	C-20	75		
029	F-29	C-21	76	29	
030	F-30	C-22	77	30	
031	F-31	C-23	79	31	
032	F-32	C-24	80	32	
033	F-33		81	33	
034	F-34		83	34	
035	F-35		84	35	
036	F-36		85	36	
037	F-37		87	37	
038	F-38	C-25	88	38	
039	F-39	C-26	89		
040	F-40	C-27	91		
041	F-41	C-28	92		
042	F-42	C-29	93		
043	F-43	C-30	100		
044	F-44	C-31	101		
045	F-45	C-32	102		
046	F-46	C-33	104		
047	F-47	C-34	105		
048	F-48	C-35	106		
049	F-49	C-36	108		
050	F-50	C-37	109		
051	F-51	C-38	110		
052	F-52	C-39	112		
053	F-53	C-40	113		
054	F-54	C-41	114		
055	F-55	C-42	116		
056	F-56	C-43	117		
057	F-57	C-44	118		
058	F-58	C-45	120		
059	F-59	C-46	121		
060	F-60	C-47	122		
061	F-61	C-48	124		
062	F-62	C-49	125		
063	F-63	C-50			
064	F-64	C-51			
065	F-65	C-52			
066	F-66	C-53			
067	F-67	C-54			
068	F-68	C-55	67		
069	F-69	C-56	68		
070			69		
071		C-57	79		
072			89		
073			103		
074			112		
075			122		

VCR CHANNEL	BROADCAST TV CHANNEL				
	SOUTH EAST ASIA	CHINA	CATV	AUSTRALIA	NEW ZEALAND
081	S-1		97		
082	S-2	Z-1	99		
083	S-3	Z-2	14		
084	S-4	Z-3	15		
085	S-5	Z-4	16	5A	
086	S-6		17		
087	S-7	Z-5	18		
088	S-8	Z-6	20		
089	S-9	Z-7	21		
090	S-10	Z-8	22		
091	S-11	Z-9	25		
092	S-12	Z-10	26		
093	S-13	Z-11	28		
094	S-14		29		
095	S-15	Z-12	30		
096	S-16	Z-13	31		
097	S-17	Z-14	32		
098	S-18	Z-15	33		
099	S-19	Z-16	35		
100	S-20	Z-17	36		
101	S-21	Z-18	37		
102	S-22	Z-19	39		
103	S-23	Z-20	40		
104	S-24	Z-21	41		
105	S-25	Z-22	43		
106	S-26	Z-23	44		
107	S-27	Z-24	45		
108	S-28	Z-25	47		
109	S-29	Z-26	48		
110	S-30	Z-27	49		
111	S-31	Z-28	51		
112	S-32	Z-29	52		
113	S-33	Z-30	53		
114	S-34	Z-31	55		
115	S-35	Z-32	56		
116	S-36	Z-33	57		
117	S-37	Z-34	59		
118	S-38	Z-35	60		
119	S-39	Z-36	61		
120	S-40	Z-37	63		
121	S-41		64		
122	X		04		
123	Y	C-4	05		
124	Z	C-5	06		
125	Z+1		95		
126	Z+2		96		
127		Z-2	29		
128		C-3			
129					
130		C-4	05		
131			97		
132			98		
133			99		
134		Z-5	18		
135			19		
136			19		
137			20		
138			09		
139			10		
140			11		
141			25		
142			26		
143			27		
144			32		
145			33		
146			34		
147			37		
148			38		

VCR CHANNEL	BROADCAST TV CHANNEL				
	SOUTH EAST ASIA	CHINA	CATV	AUSTRALIA	NEW ZEALAND
149			41		
150			42		
151		Z-12	45		
152		Z-12	46		
153			49		
154			50		
155			53		
156		Z-12	54		
157			57		
158		Z-12	58		
159			61		
160		Z-12	62		
161			66		
162			67		
163			69		
164			70		
165			71		
166			73		
167			74		
168			75		
169			77		
170			78		
171			81		
172			82		
173			83		
174			85		
175			86		
176			87		
177			90		
178			91		
179			93		
180			94		
181			100		
182			102		
183			104		
184			106		
185			107		
186			108		
187			110		
188			111		
189			114		
190			115		
191			116		
192			118		
193			119		
194			120		
195			123		
196			124		
197					
198					



Auto Tuning

Preparation

- Press **OPERATE**. Then move the **VCR/DVD CHANGE Switch** to **VCR**.
- Ensure the Video channel is selected on the TV.

1 Press **VCR MENU**. Press **▲ / ▼** to select "CHANNEL PRESET". Press **SET** to confirm.

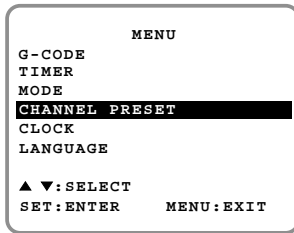

2 Press **▲ / ▼** to select "AUTO". Press **SET** to confirm.

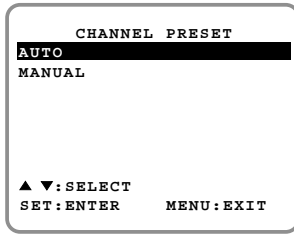

3 Press **◀ / ▶** to select the SYSTEM you desire. Press **SET** to confirm. Select the broadcast system used for areas where I, B/G, D/K, M reception is necessary. (For DV-NC70X, only B/G and D/K will appear on the screen.)

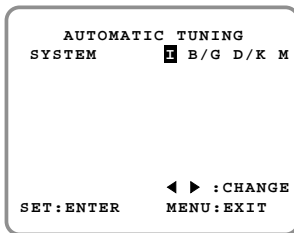

		I, B/G, D/K, M (Receiving system)
Ex.	Hong Kong	I
	China, Russia	D/K
	South East Asia, Australia, New Zealand	B/G
	U.S.A., Japan, Philippine	M



NOTE

- If the broadcast signal system does not match the Product receiving system, tuning is not possible.

4 The channel display on the TV screen will continue through all of the channels and when finished, the TV screen will return to the MOVE (channel sort) screen. The bar display indicates the estimated amount of channels tuned.



- To change the order of tuned-in broadcast, press ▲ / ▼ / ◀ / ▶ to select the channel to be moved. Press **SET** to confirm .
"SELECTED: CH078" will appear.

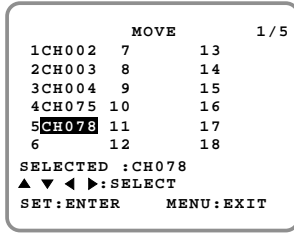

- Press ▲ / ▼ / ◀ / ▶ to select the new position for the channel. Then, press **SET** to confirm.
"SELECTED: CH078" will disappear.

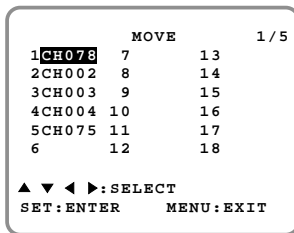

- To move additional channels, repeat steps 5 and 6.
- When the channels have been sorted into the desired order, press **VCR MENU** to return to the normal screen.



NOTE

- If additional unwanted channels are found, refer to page 32 to skip them.
- If some channels are unable to be found, refer to "Manual Tuning" the next page.



Manual Tuning

Preparation

- Press **OPERATE**. Then move the **VCR/DVD CHANGE Switch** to **VCR**.
- Ensure the Video channel is selected on the TV.

Example: Tuning Channel Position 48 to Broadcast TV Channel E7 (VCR CHANNEL 007 for system I area.)

- 1 Press **VCR MENU**. Press **▲ / ▼** to select "CHANNEL PRESET" and press **SET** to confirm.

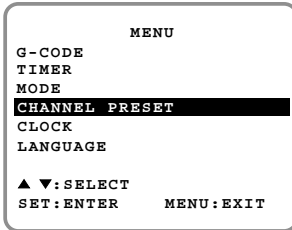

- 2 Press **▲ / ▼** to select "MANUAL" and press **SET** to confirm.

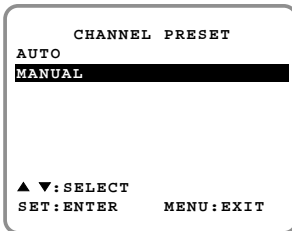

- 3 Select the preset channel position number 48 with the number buttons (0 to 9) or **◀ / ▶** and press **▼**.

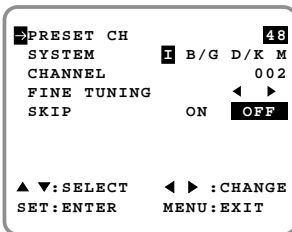

- 4 Press **◀ / ▶** to select the "SYSTEM" you desire and press **▼**. (For DV-NC-70X, only B/G and D/K will appear on the screen.)

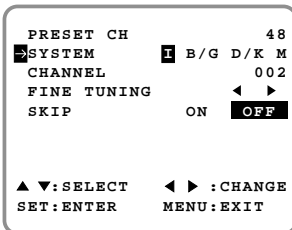



- 5 Press the number buttons (0 to 9) or ◀/▶ until you see the desired broadcast channel E7 (VCR CHANNEL 007) on your TV and press ▼.

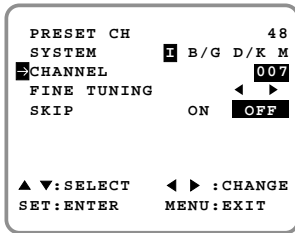

- 6 For fine tuning, press ◀/▶ until the broadcast channel comes in clearly on your TV.

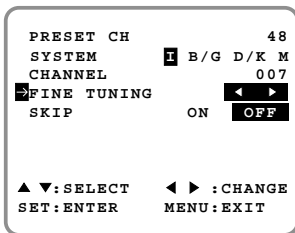

- 7 To check that the broadcast channel you tuned the Product to is VHF E7, select channel 7 using the TV tuner.

- 8 Select the video channel on your TV again.
 - If the channel you tuned the Product to and the one on the TV do not match, repeat steps 5 through 7.

- 9 Press **SET**. (This will set channel position 48 in memory and return to channel position 49 for tuning.)

- 10 If you want to set additional channels, repeat steps 3 through 9.

- 11 Press **VCR MENU** to return to the normal screen.

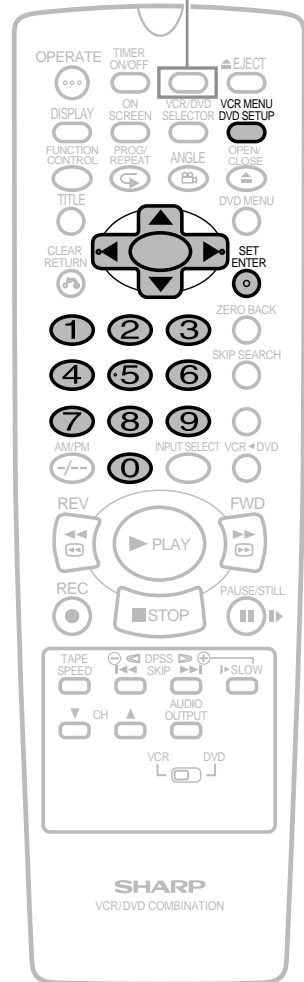

NOTE

- Use Auto Tuning normally for presetting.
 - ① Auto tuning may not be able to preset some broadcasts. Use manual tuning to preset.
 - ② The same broadcast may be preset more than once. Select the channel with the clearer broadcast.
 - ③ After auto tuning is completed, confirm the preset channels in order. If no sound can be heard from any of the preset channels, reset the SYSTEM (I, B/G, D/K, M) with manual tuning.



Channel Skip/Cancelling Skip

Channel Skip

If there are channel positions that are not preset, you can skip them with the following procedure.

Preparation

- Press **OPERATE**. Then move the **VCR/DVD CHANGE Switch** to **VCR**.

Example: Skip channel position 12.

- 1 Press **VCR MENU**. The menu screen will appear. Press **▲/▼** to select "CHANNEL PRESET" and press **SET** to confirm.

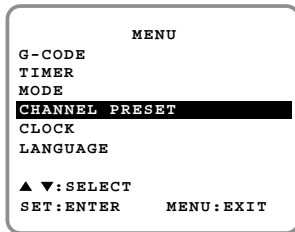

- 2 Press **▲/▼** to select "MANUAL". Press **SET** to confirm.

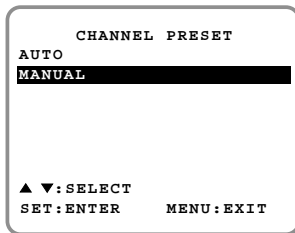

- 3 Set the channel position you wish to skip with **◀/▶** or number buttons (0 to 9).

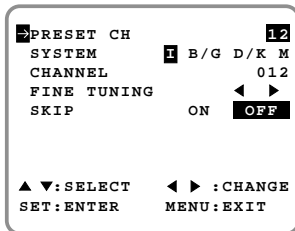

- 4 Press **▲/▼** to select "SKIP".

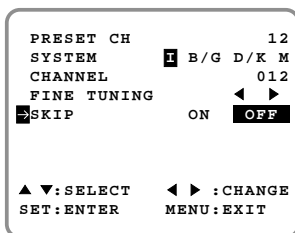



5 Press ◀/▶ to set "ON" and press SET to confirm.

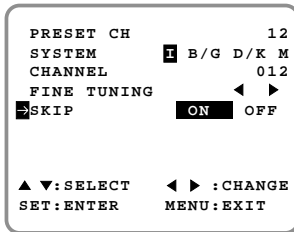

6 If you wish to set more channels to be skipped, repeat steps 3 through 5.

7 Press VCR MENU to return to the normal screen.

NOTE

- When making channel inputs with the number buttons (0 to 9), first select the one figure input or two figures input using the **-/-** button on the Remote.



Cancelling Skip

Example: Reset channel position 12.

- 1 Follow the steps 1 and 2 from “Channel Skip” on page 32.
- 2 Select the channel position you wish to unskip with ◀/▶ or number buttons (0 to 9).

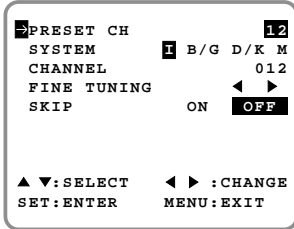

- 3 Press ▲/▼ to select “SKIP”.

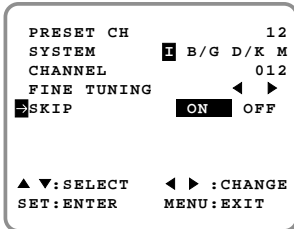

- 4 Press ◀/▶ to set “OFF” and press SET to confirm.

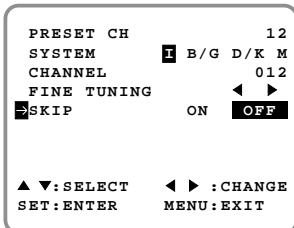

- 5 If you wish to unskip more channels, repeat steps 2 through 4.
- 6 Press **VCR MENU** to return to the normal screen.





Setting the Clock

When you use the Product for the first time or after a power failure of more than 60 minutes the clock has to be reset. Apply power to the Product to switch it on. Then perform the following procedure.

Initial Setting of Clock

- 1 First set the language and system setting. (See page 21.) Then press **SET**.
- 2 Press **▲/▼** to select whether the clock should show 12-hour AM/PM time or 24-hour time and press **▶**.

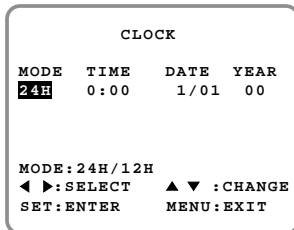

- 3 Set the present time with the number buttons (0 to 9) or **▲/▼** on the Remote and press **▶**. (First set the "hour" digits and the "minute". If there is only one "hour" or one "minute" digit, enter a 0 first.)

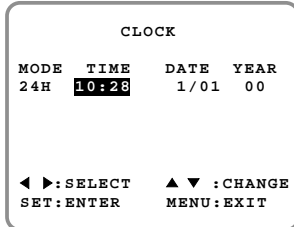

NOTE

- If 12H mode is selected, set the AM or PM indicator.

- 4 Set the date with the number buttons (0 to 9) or **▲/▼** on the Remote and press **▶**. (First set the "day" digits and then the "month". If there is only one "day" or one "month" digit, enter a 0 first.)

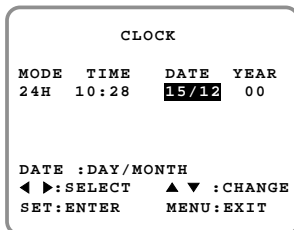



- Set the year digits with the number buttons (0 to 9) or ▲ / ▼ on the Remote. (If there is only one “year” digit, enter a 0 first.)

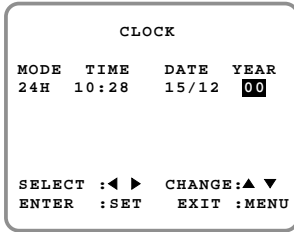

- Press **SET** to return to the normal screen.

Changing the Clock Setting

- If the clock has already been set previously and you want to change it, select “CLOCK” from the MENU, and then follow the steps 1 to 6 from “Initial Setting of Clock” on pages 35 and 36.
- Press **VCR MENU**. Press ▲ / ▼ to select “CLOCK” and press **SET** to confirm. Press **VCR MENU** to return to the normal screen.

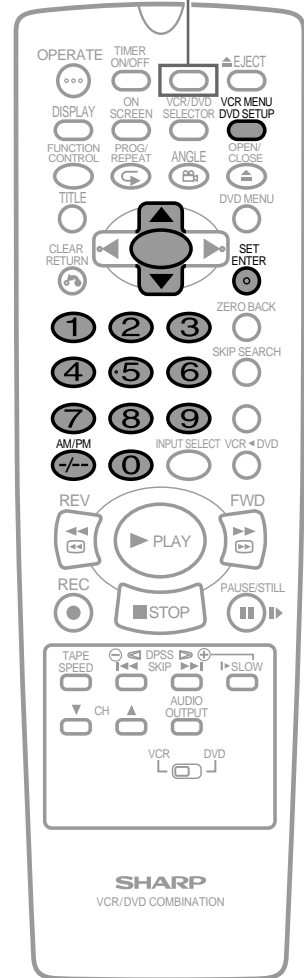
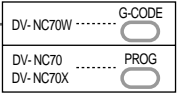
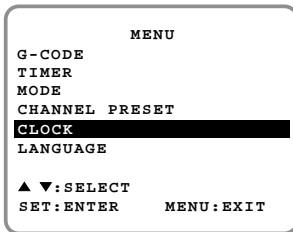

NOTE

- If the precise clock time is required (within a second), do not press **SET** until the exact start of the minute after setting the year (after completing step 5). The clock will start operation as soon as **SET** is pressed.
- If you prefer the clock display time in the 12-hour AM/PM system, select “12H” in step 2. In this case, when you set the present time using the number buttons, first press **AM/PM** on the Remote to select AM or PM, and then set the present time.



Setting the Language

This Product is factory preset to display the LANGUAGE setting screen after **VCR MENU** is pressed when the Product is operated for the first time. In some cases, the retailer may have already set the language, and the CLOCK setting screen will appear after **VCR MENU** is pressed. To reset the Product, perform the following steps.

VCR-RESET

- 1 Press **OPERATE** to POWER OFF on the Product.
- 2 Press **OPERATE** to POWER ON on the Product.
- 3 Press **VCR MENU** and **CH ▼** on the Remote at the same time for five seconds. (The LANGUAGE setting screen should appear.)

NOTE

- When the Product is reset, all channel settings, guide channel setting for the G-CODE system and timer setting will be cancelled.

Initial Setting of Language

Preparation

- Press **OPERATE**. Then move the **VCR/DVD CHANGE Switch** to **VCR**.

- 1 Press **▲ / ▼** to select the language and press **SET** to confirm.

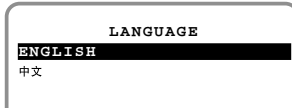

Changing Language

If the language has already been set previously and you want to change it, follow the steps below.

- 1 Press **VCR MENU**. Press **▲ / ▼** to select "LANGUAGE " and press **SET** to confirm.

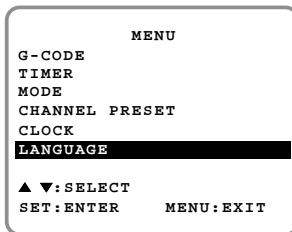

- 2 Select the language with **▲ / ▼** and press **SET** to confirm.

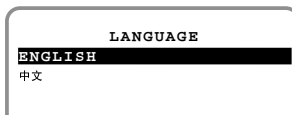

- 3 Press **VCR MENU** to return to the normal screen.



VCR Display Information

The tape counter and VCR mode can be shown on the screen while you are playing back a tape or watching a broadcast on the video channel.

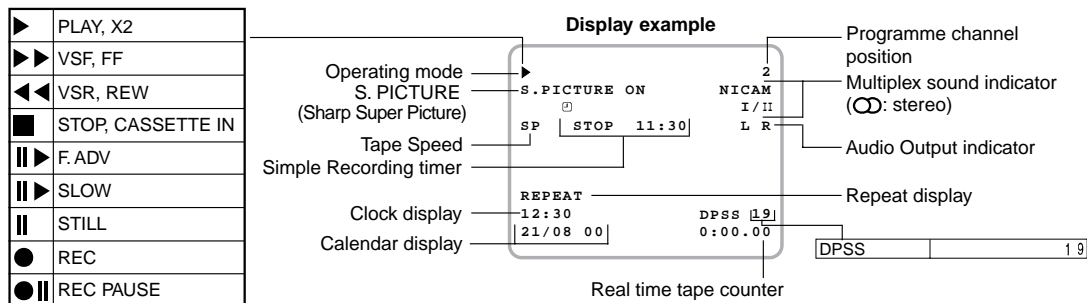

How to Display Indicators

- 1 Turn on your TV and select the video channel.
- 2 Press **OPERATE** to turn on the Product. Mode indicators are displayed in the AUTO display screen.
- 3 Each time **ON SCREEN** is pressed, the screen changes as follows:

→AUTO Display → FULL Display → Counter Display → Display Off →

AUTO DISPLAY

When an operation button, number buttons or **CH ▲ / ▼** is pressed, the current mode or the number of the channel will be displayed in the upper section of the TV screen for about 3 seconds.

NOTE

- When you record a video signal output from this Product on another VCR, press **ON SCREEN** to select Display Off. (If the mode indicator is displayed on the screen, it is also recorded on the tape.)

VCR Front Panel Display

Each time **DISPLAY** on the Remote is pressed, the display changes in the following way. (However, the following is the case when the clock time is set and displayed in the 12-hour system.)

→Channel setting mode → Tape counter mode → Clock mode→

- **Channel setting mode** .. The number of the channel will be displayed. It does not display during playback.
- **Tape counter mode** The current tape position will be displayed.
- **Clock mode** The current time will be displayed.

The meaning of the main indicators is shown below. (This list does not include all indicators.)

Display Examples

	Cassette-In Indicator		Slow, Still, Frame Advance
	Playback		When AC power cord is first plugged in
	Rewind, Video Search Rewind		Stop
	Fast forward, Video Search Forward		LINE IN 1/2
	Record		
	Rec Pause		

NOTE

- Tape counter is displayed during playback, fast forward or rewind operation.
- When the power is turned off, the clock is displayed and the VCR Front Panel Display Becomes darker.
- The display will return to the original mode (counter or clock display) 3 seconds after the VCR enters the operation mode.

DVD Setup

DVD Setup	40
About the SETUP Screen	40
TV MODE Setting	41
PARENTAL Level Setting	42
AUDIO Setting	44
Setting the COMPRESSION (Dolby Digital output level)	44
Setting the DOLBY DIGITAL	45
Setting the MPEG	46
Setting the CINEMA VOICE	46
DISC LANGUAGE Setting	47
Setting SUBTITLE, AUDIO and MENU languages	47
Selecting languages from OTHER	48
DVD Display Information	49
Operation Mode Indicators	49
Language Code List for Disc Language	50

About the SETUP Screen

This section describes how to specify various basic settings using the SETUP screen. The list below shows all the items you can set and adjust. See the following pages for details on each setup procedure.

- The setting procedures described on the following pages are available only in STOP mode.
- The OSD (On Screen Display) screens used in this Operation Manual are purely for the purposes of explanation. The actual displays (set displays) may differ slightly from what is shown here.

(Example) TV MODE

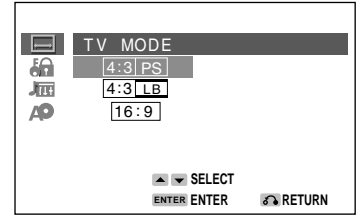

! Important!

- When you set the language to be used in the OSD, changing the mode to "VCR" and select "LANGUAGE" in the menu screen. See **OSD Language Setting** on page 37 for details.

Setup item list

Main Menu

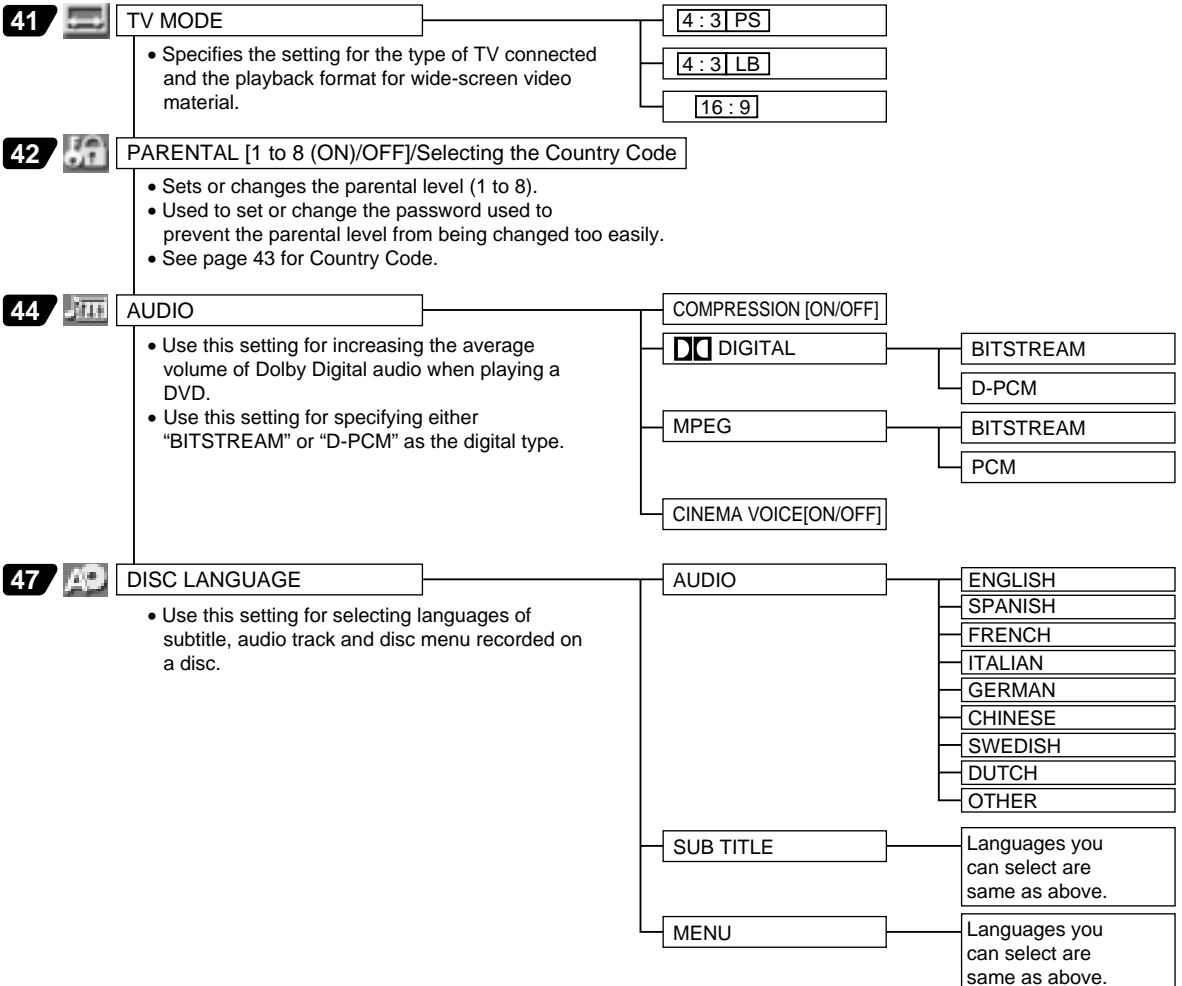

- Numbers in refer to the pages where the setting procedures are described.



TV MODE Setting

Preparation

- See **Preparing to Watch a DVD** on page 18.

- 1 While this product is stopped, press **DVD SETUP** to display the SETUP screen.
- 2 Use **▲** or **▼** to select the “ TV MODE”.



- 3 Press **ENTER** to display the items you can select.
- 4 Use **▲** or **▼** to select **4:3 PS**, **4:3 LB** or **16:9**.
(Example) Selecting **4:3 PS**.

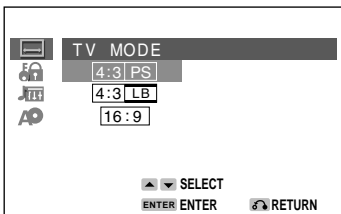

- **4:3 PS** — (Pan & Scan mode): When wide-screen video material is played, this mode clips the right and left sides of the image so that it can be viewed on a conventional TV screen.
 - Some wide-screen DVDs that do not permit Pan & Scan mode playback are automatically played in letterbox mode (black bands top and bottom).
- **4:3 LB** — (Letterbox mode): When wide-screen video material is played in this mode on a conventional TV screen, black bands appear at the top and bottom of the screen.
- **16:9** — (Wide-screen TV): This is the correct mode for playing wide-screen videos on a wide-screen TV.
 - You must also set the screen mode on your wide-screen TV to “FULL”.

- 5 Press **ENTER** to confirm the “TV MODE” setting.
- 6 If you want to complete the settings here, press **RETURN** to exit the SETUP screen and return to the normal screen.
 - If you intend to go on and specify other settings (PARENTAL, AUDIO or DISC LANGUAGE), press **▲** or **▼** to display other SETUP screen without pressing **RETURN**.



Cut off when a wide-screen video image is played.

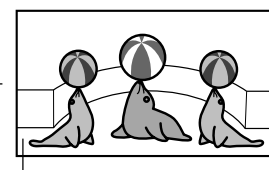
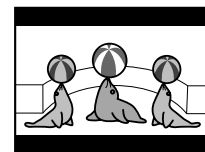
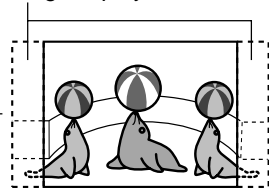

The actual appearance of the image depends on the screen mode setting of your wide-screen TV.



PARENTAL Level Setting

Certain discs come preset with country codes and parental level settings defined for particular countries. Discs equipped with the parental lock function are rated according to their content. The rated content allowed by a parental lock level and the way a DVD can be controlled vary from disc to disc. Some discs, for example, may let you edit out scenes and replace them with scenes suitable for children. You can also use the parental lock to completely disable playback of the DVD.

Preparation

- See **Preparing to use DVD** on page 78.

- 1 Press **DVD SETUP** to display the SETUP screen.
- 2 Use **▲** or **▼** to select the "PARENTAL" and then press **ENTER**.
 - The password specification and verification screen appears. For DV-NC70X model, the parental country code is "Australia".

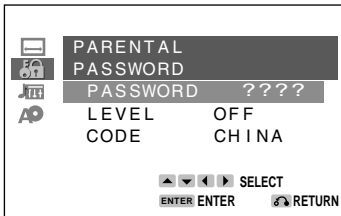

- If you have already set your password, (password verification display) appears.

- 3 Use the number buttons (0 to 9) to enter a 4-digit password.

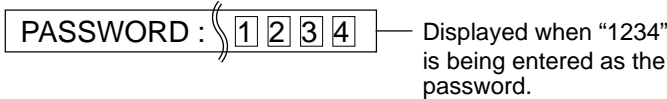

NOTE

- Enter the numbers slowly as each number is stored separately.
- If you enter the wrong number three times in succession, the normal screen reappears.

If you forget your password, you can erase your current password by pressing **STOP** four times.

- 4 The cursor is moved to "LEVEL" and then press **ENTER**.

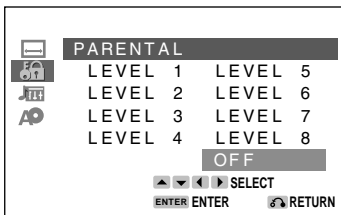



5 Press ▲, ▼, ► or ◀ to select the desired parental level and then press ENTER.

(Example) Selecting "LEVEL 8"

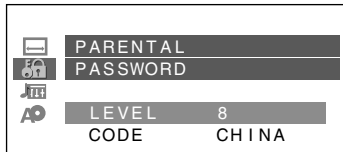

- Level 1: for most restricted viewing → Level 8: for adult viewing (The smaller the number, the greater the level of restriction.)
- When "PARENTAL" is set to "OFF", DVD discs can be played back regardless of the parental level.

The parental level set up for CHINA is prepared for future use. As for the set up of an appropriate level, please check the level when you purchase your DVD disc equipped with the parental feature.

6 Press ▼ to select "CODE" and then press ENTER.

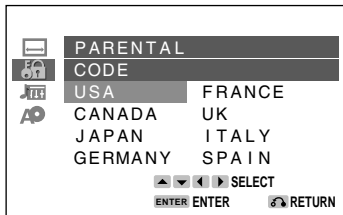

7 Press ▲, ▼, ► or ◀ to select the desired country code and then press ENTER.

- If you want to go to next page, select the country code displayed at the bottom, and then press ▼.

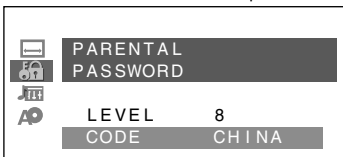

8 Press RETURN to return to the SETUP screen.

- If you want to go on and specify the other settings, use ▲ or ▼ to display other SETUP screen. However, press RETURN if you want to exit the SETUP screen.

! Important!

- Be sure to try playing back the disc to confirm that the parental level setting is working correctly. If it is not working correctly, try changing the country code.

NOTE

- You can use the parental lock function only with DVD discs that are equipped with the parental lock feature.
- On some DVD discs, the PARENTAL level setting is fixed and cannot be modified.
- The parental level depends on countries. If you do not set the country code correctly, it fails to work correctly.
- Some DVD discs allow the viewer to temporarily change the parental level setting to view the original scenes. When this prompt appears, input the password to view the original scenes.



Country Code List



USA	FINLAND
CANADA	BELGIUM
JAPAN	HONG KONG
GERMANY	SINGAPORE
FRANCE	THAILAND
UK	MALAYSIA
ITALY	INDONESIA
SPAIN	TAIWAN
SWISS	PHILIPPINE
SWEDEN	AUSTRALIA
HOLLAND	RUSSIA
NORWAY	CHINA
DENMARK	

AUDIO Setting

- COMPRESSION Use this setting for increasing the average volume of Dolby Digital audio when playing a DVD.
- DIGITAL Use this setting for specifying the type of digital output when playing a disc.
- CINEMA VOICE Use the setting for raising the sound of the center speaker to make the voices in a movie easier to hear.

Setting the COMPRESSION (Dolby Digital output level)

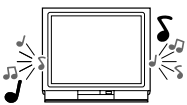
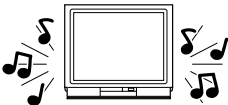
When Dolby Digital is used to record the audio on a DVD disc, the average overall volume level of the audio is relatively lower than that produced by a VIDEO CD/Audio CD. This is to provide the widest possible dynamic range. To counteract this, this product automatically raises the overall average volume level of a disc recorded using Dolby Digital to a level that is similar to that of a VIDEO CD/Audio CD.

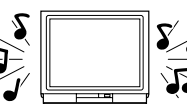
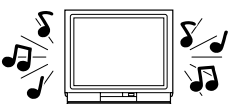
	COMPRESSION: OFF	COMPRESSION: ON
 DVD Dolby Digital audio	 • Low audio level	 • Audio level the same as audio CD, etc.
 VIDEO CDs Audio CDs		

- **OFF** Audio level recorded on disc is played back without modification.
- **ON** Dolby Digital average audio level is increased so it sounds similar to that of a VIDEO CD/Audio CD.

Preparation

- See **Preparing to Watching a VCR or a DVD** on page 18.

- 1 Press **DVD SETUP** to display the SETUP screen.
- 2 Use **▲** or **▼** to select the “ AUDIO” and then press **ENTER**.

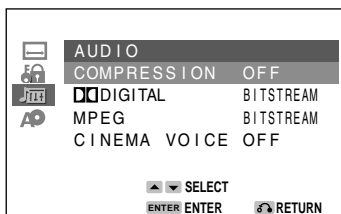



- Use ▲ or ▼ to select "COMPRESSION".
- Press ENTER to display the settings you can select.

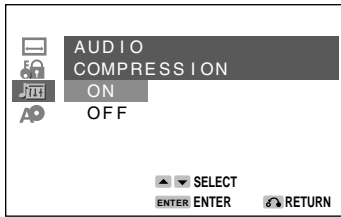

- Use ▲ or ▼ to select "ON" or "OFF".
 - Use of the "OFF" setting is recommended when the product is connected to audio equipment.
- Press ENTER to confirm the setting.
 - When you have completed the above setting, press RETURN to return to the SETUP screen. However, if you want to specify the "DIGITAL" setting in succession, proceed to step 1 below.

DV-NC70W	G-CODE
DV-NC70	PROG
DV-NC70X	



NOTE

- Whenever the "COMPRESSION" setting is "ON", the 3D VIRTUAL SURROUND setting is automatically changed to "OFF".

Setting the DOLBY DIGITAL

When playing a disc recorded using Dolby Digital (5.1ch), you can specify either "BITSTREAM" or "D-PCM" as the digital type output.

- Before setting the "DIGITAL", perform the step 1 and 2 on page 46.

- Use ▲ or ▼ to select "DIGITAL".
- Press ENTER to display the settings you can select.

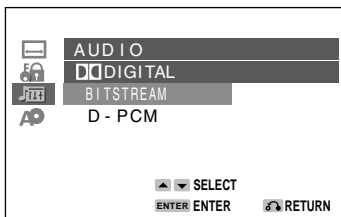

- Use ▲ or ▼ to select "BITSTREAM" or "D-PCM".
 - BITSTREAM:** Use this setting for a digital connection of a receiver (amplifier) equipped with a Dolby Digital decoder.
 - D-PCM:** Use this setting for a digital connection to the PCM digital input jack of a DAT or MD, or for a digital connection to a receiver (amplifier) that does not have a Dolby Digital decoder.

- Press ENTER to confirm the setting.
- When you have completed the setting above, press RETURN to return to the SETUP screen. However, if you want to go on and specify the other settings, use ▲ or ▼ to display other setting screen.



Setting the MPEG

- Before setting the “MPEG”, perform the step 1 to 2 on pages 47 and 48.

- 1 Press **ENTER** and then use **▲** or **▼** to select “MPEG”.
- 2 Press **ENTER** to display the settings you can select.

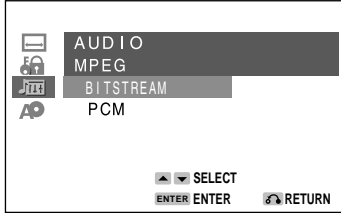

- 3 Use **▲** or **▼** to select “BITSTREAM” or “PCM”.

BITSTREAM: Use this setting for a digital connection of a receiver (amplifier) equipped with an MPEG Audio decoder.

PCM: Use this setting for a digital connection to the PCM digital input jack of a DAT or MD, or for a digital connection to a receiver (amplifier) that does not have an MPEG Audio decoder.

- 4 Press **ENTER** to confirm the setting.
- 5 Press **RETURN** to exit the SETUP screen and return to normal screen.
 - If you want to go on and specify other settings, use **▲** or **▼** to display the other SETUP screen without pressing **RETURN**.

When playing a disc recorded using DTS, the bitstream type signal is output regardless of the setting of “**□□ DIGITAL**” and “MPEG”.

Setting the CINEMA VOICE

This function is raising the sound of the center speaker to make the voices in a movie easier to hear.

- Before setting the “CINEMA VOICE”, perform the step 1 and 2 on page 46.

- 1 Use **▲** or **▼** to select “CINEMA VOICE”.
- 2 Press **ENTER** to display the settings you can select.

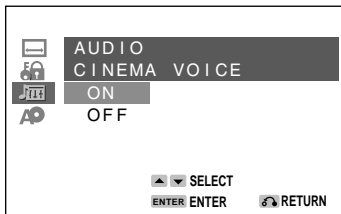

- 3 Use **▲** or **▼** to select “ON” or “OFF”.

ON: Set to “ON” when you want to raise the sound of the voice.

OFF: Set to “OFF” when you do not want to use this function.

- 4 Press **ENTER** to confirm the setting.
- 5 When you have completed the setting above, press **RETURN** to return to the SETUP screen. However, if you want to go on and specify the other settings, use **▲** or **▼** to display other setting screen.

DV-NC70W	G-CODE
DV-NC70	PROG
DV-NC70X	



NOTE

- The CINEMA VOICE setting raises the sound of the center channel therefore it does not affect the voices in other channels.
- Even if this function is set to “ON”, the result may or may not be effective depending on the disc.



DISC LANGUAGE Setting

Use this setting for selecting the language for subtitles, audio tracks and disc menu.

Setting SUBTITLE, AUDIO and MENU languages

Preparation

- See **Preparing to Watch a VCR or a DVD** on page 18.

- 1 Press **DVD SETUP** to display the SETUP screen.
- 2 Use **▲** or **▼** to select the “**DISC LANGUAGE**”.



- 3 Press **ENTER** and then use **▲** or **▼** to select “AUDIO”, “SUB TITLE” or “MENU”.
 - You can set “AUDIO”, “SUB TITLE” or “MENU” individually.
 (Example) Selecting “AUDIO”

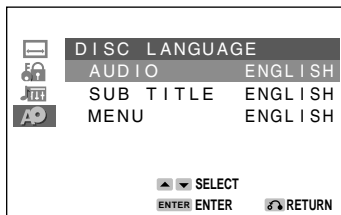

- 4 After selecting the item, press **ENTER**.
 - After selecting “MENU”, make sure to set the language by following steps 2 to 5 under “Selecting languages from OTHER” on the next page.

- 5 Select the language you want to use with **▲**, **▼**, **◀** and **▶**.
 (Example) Selecting “FRENCH”

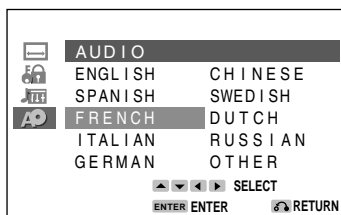

- If you want to use any languages which are not on the OSD, proceed to step 1 under “Selecting languages from OTHER” on the next page.

- 6 Press **ENTER** to confirm the setting.

- 7 Repeat steps 4 to 7 above to go on with other “DISC LANGUAGE” settings in succession.

- If you want to complete the setting here, press **RETURN** to return to the SETUP screen. However, if you want to display other setting screens, press **▲** or **▼** without pressing **RETURN**.





Selecting languages from OTHER

- 1 Select "OTHER" with ▲, ▼, ◀ and ▶, then press **ENTER** to set the "OTHER" input item (two letters).
 - See **Language Code List for Disc Language** on page 50 when selecting the code.

(Example) Selecting "OTHER" in "AUDIO"

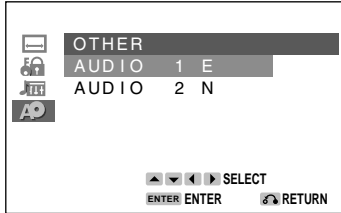

- The "SUB TITLE" and "MENU" screens are displayed respectively when being set.
- 2 Press ◀ or ▶ to select the alphabet as the first letter on "AUDIO 1". (Upper side)
 - 3 Press ▼ to move the cursor to "AUDIO 2". (Lower side)

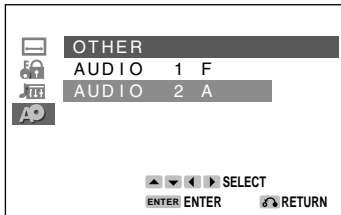

- 4 Press ◀ or ▶ to select the alphabet as the second letter.
- 5 Press **ENTER** to confirm the setting.

NOTE

- Press **RETURN** to return to the previous screen.



Operation Mode Indicators

Each time **ON SCREEN** on the Remote is pressed, the display on the TV screen changes the mode in the following sequence:

→AUTO mode → ON mode → OFF mode→

- **AUTO mode** Displays indicators for 3 seconds when operation begins.
- **ON mode** Displays indicators continually until the operation mode is changed.
- **OFF mode** Does not display indicators.

Each time **DISPLAY** on the Remote is pressed, the DVD Front Panel Display changes the mode in the following sequence:











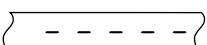



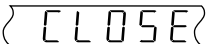

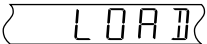

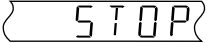
→Time mode → Operation Status mode → Title mode→

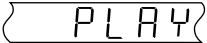
- **Time mode** Displays the playing time*.
- **Operation Status mode** Displays the operation you perform such as "PLAY", "REV".
- **Title mode** Displays the total number of titles, chapters, or tracks.

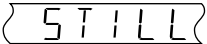
* When the disc you attempt to play has no information on time, the operation status is displayed.

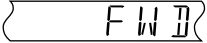
This product displays the information shown below on the TV screen and on the DVD Front Panel Display depending on the operation status.

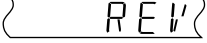
Display Examples

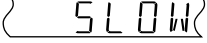
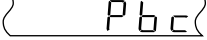
	TV Screen	DVD Front Panel Display	Remarks
If no disc is loaded or an unplayable disc is loaded when this product is switched on			"- - - - -" appears when the tray is closed and: 1) There is no disc in the tray. 2) The disc type is not DVD, VIDEO CD or Audio CD. 3) The disc is not loaded correctly (upside-down, etc.)
Tray open			
Tray closed			
Loading			
Stopped			The indicator changes to show other indicators (total time, etc.)
Playing			
Still/Paused			When a DVD or VIDEO CD is played back.
			When an Audio CD is played back.
Fast forward			
Fast reverse			
Slow			Does not work with Audio CDs.
Playback Control			

Region (Local) Number Error Indicator

If the region (local) number of the disc that you attempt to play differs from the region number of this product, "REGION CODE ERROR" appears on the TV screen and the disc tray slides out. (The disc cannot be played.)



Language Code List for Disc Language

Code	Language Name	Code	Language Name	Code	Language Name	Code	Language Name
AA	Afar	FY	Frisian	MG	Malagasy	SL	Slovenian
AB	Abkhazian	GA	Irish	MI	Maori	SM	Samoan
AF	Afrikaans	GD	Scots Gaelic	MK	Macedonian	SN	Shona
AM	Ameharic	GL	Galician	ML	Malayalam	SO	Somali
AR	Arabic	GN	Guarani	MN	Mongolian	SQ	Albanian
AS	Assamese	GU	Gujarati	MO	Moldavian	SR	Serbian
AY	Aymara	HA	Hausa	MR	Marathi	SS	Siswat
AZ	Azerbaijani	HI	Hindi	MS	Malay	ST	Sesotho
BA	Bashkir	HR	Croatian	MT	Maltese	SU	Sundanese
BE	Byelorussian	HU	Hungarian	MY	Burmese	SV	Swedish
BG	Bulgarian	HY	Armenian	NA	Nauru	SW	Swahili
BH	Bihari	IA	Interlingua	NE	Nepali	TA	Tamil
BI	Bislama	IE	Interlingue	NL	Dutch	TE	Telugu
BN	Bengali; Bangla	IK	Inupiak	NO	Norwegian	TG	Tajik
BO	Tibetan	IN	Indonesian	OC	Occitan	TH	Thai
BR	Breton	IS	Icelandic	OM	(Afan) Oromo	TI	Tigrinya
CA	Catalan	IT	Italian	OR	Oriya	TK	Turkmen
CO	Corsican	IW	Hebrew	PA	Panjabi	TL	Tagalog
CS	Czech	JA	Japanese	PL	Polish	TN	Setswana
CY	Welsh	JI	Yiddish	PS	Pashto, Pushto	TO	Tonga
DA	Danish	JW	Javanese	PT	Portuguese	TR	Turkish
DE	German	KA	Georgian	QU	Quechua	TS	Tsonga
DZ	Bhutani	KK	Kazakh	RM	Rhaeto- Romance	TT	Tatar
EL	Greek	KL	Greenlandic	RN	Kirundi	TW	Twi
EN	English	KM	Cambodian	RO	Romanian	UK	Ukrainian
EO	Esperanto	KN	Kannada	RU	Russian	UR	Urdu
ES	Spanish	KO	Korean	RW	Kinyarwanda	UZ	Uzbek
ET	Estonian	KS	Kashmiri	SA	Sanskrit	VI	Vietnamese
EU	Basque	KU	Kurdish	SD	Sindhi	VO	Volapük
FA	Persian	KY	Kirghiz	SG	Sangho	WO	Wolof
FI	Finnish	LA	Latin	SH	Serbo- Croatian	XH	Xhosa
FJ	Fiji	LN	Lingala	SI	Singhalese	YO	Yoruba
FO	Faroese	LO	Laothian	SK	Slovak	ZH	Chinese
FR	French	LT	Lithuanian			ZU	Zulu
		LV	Latvian, Lettish				

Watching the VCR

Playback	52
Inserting a Video Cassette	52
Playback	52
Video Search (with the Remote)	52
Fast Forwarding and Rewinding	53
Slow Motion Playback (with the Remote)	53
Still Picture and Frame Advance	53
Double Speed Playback	53
NTSC Tape Play Back on PAL TV	54
Full Auto Playback	54
Auto Head Cleaning System	54
Auto Tracking Control System	54
Quick Start with Full Loading Mechanism	54
AUTO RENTAL	55
COLOUR	55
BLUE BACK	56
Playback of Hi-Fi Recorded Tapes	57
Audio Output Mode	57
Adjusting Hi-Fi Audio Tracking	57
Sharp Super Picture	58
Auto Repeat	59
Auto Zero Back	60
DPSS (Digital Program Search System)/Skip Search	61
DPSS	61
Skip Search	61
TV Programme Recording	62
Cassette Erase Protection	62
Recording a TV Programme	62
To Watch Another TV Programme While Recording	62
Recording NICAM/IGR Multiplex Broadcasts	63
Simple Recording Timer	64
Immediate Recording	64
Programming the Timer with G-CODE® System (DV-NC70W only)...	65
Setting the Programme Number In Step 4	67
Recording with the Timer	68
Confirming Timer Programmes	71
Cancelling Timer Programmes	72
Tape Dubbing	73
Recording a DVD Disc onto a Video Cassette	74
Recording a DVD disc onto a Video cassette (Tape Editing mode)	74

Inserting a Video Cassette

Gently insert the video cassette into the cassette compartment. The Product turns on automatically. If the cassette is inserted incorrectly, the loading system will not function. Do not force the cassette into the Product. When the cassette has been properly loaded, "000" appears on the VCR Front Panel display. To remove the cassette, press **EJECT** during stop mode.

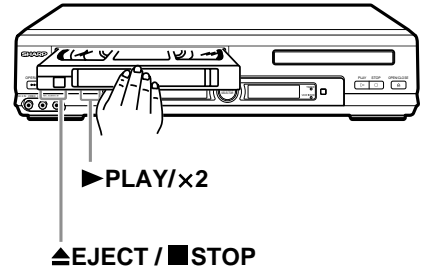

Playback

- 1 Switch on your TV and select the video channel.
- 2 Press **OPERATE** to turn on the Product.
- 3 Insert a cassette.
- 4 Press **▶PLAY**. (The auto tracking control system engages and "▶" flashes on the TV screen for a few seconds.)
- 5 Press **■STOP** to stop playback. (If the tape reaches its end, the Product will automatically rewind the tape to the beginning, eject the cassette, and turn off the power. If a DVD is being played back, the power will not turn off.)

NOTE

- NTSC tapes recorded in Hi-Fi and EP mode may appear distorted during playback. This does not indicate a malfunction. The tracking function can be used to slightly enhance the picture quality.

Video Search (with the Remote)

Use the following procedure to quickly find the section you want, while viewing the picture.

- 1 During playback, press **FF▶▶** for forward video search, or **◀◀REW** for reverse search.

There are 2 search speeds in each direction. The Product switches between them each time the button is pressed.

- 2 Press **▶PLAY** to resume normal playback.

NOTE

- During video search of a tape recorded in the LP mode and EP mode, the upper part of the picture may be skewed to one side.

TAPE SPEED

		VSF/VSR①	VSF/VSR②
PAL TAPE MESECAM TAPE	SP	x 5	x 9
	LP	x 5	x 11
PAL TAPE	EP	x 9	x 27
NTSC TAPE	SP/LP	x 5	x 7
	EP	x 9	x 21

- VSF : Video Search Forward
- VSR : Video Search Reverse

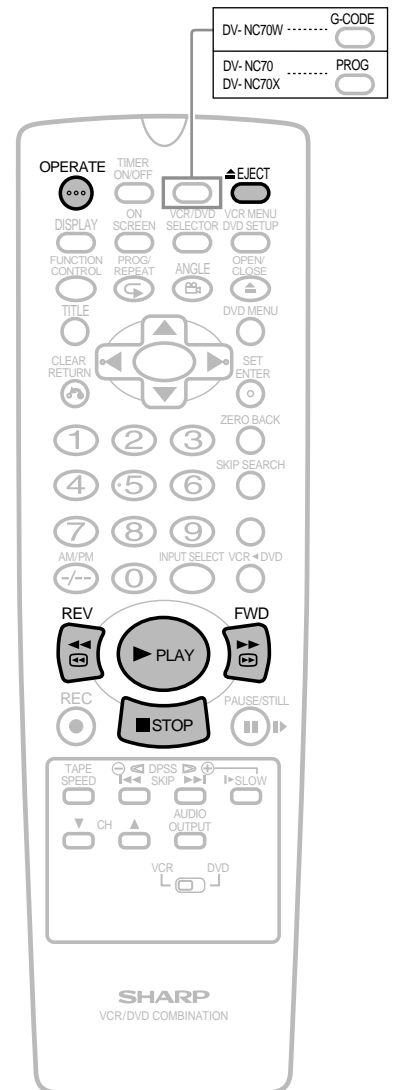



Fast Forwarding and Rewinding

- 1 Press **■STOP** to stop the video tape.
- 2 Press **FF▶▶** or **◀◀REW**.
- 3 Press **■STOP** to stop fast forward/rewind.

NOTE

- If you use other than E-90/E-180 cassettes, fast forward and rewind may take somewhat longer.

Slow Motion Playback (with the Remote)

- 1 Press **▶SLOW** on the Remote during playback.
- 2 Press **SLOW⊖/⊕** (to the left of **▶SLOW**) to vary the slow motion playback speed between 1/5 and 1/30 of the normal playback speed.
- 3 Press **▶PLAY** to resume normal playback.

NOTE

- No noise can be erased when a tape recorded in the NTSC SP mode is played back in special modes (still, slow motion, etc.). However, this does not indicate a malfunction with the Product.
- During slow motion, still picture, frame advance and double speed playback with a tape recorded in the PAL EP mode, noise may appear.

Still Picture and Frame Advance

- 1 Press **||PAUSE/STILL** during playback. This will freeze the picture on your TV.
- 2 If noise bars appear on the screen during still picture, set your Product to the slow mode and press **CH ▲ / ▼** to make the noise disappear. Then press **||PAUSE/STILL** again.
- 3 If there is vertical jitter during still picture playback, press **CH ▲ / ▼** to stop jitter.
- 4 Press **||PAUSE/STILL** during still mode for frame advance.
- 5 Press **▶PLAY** again to resume normal playback.

Double Speed Playback

- 1 Press **▶PLAY** during playback. The tape will be played back at twice the normal speed.
- 2 Press **▶PLAY** to resume normal playback.

NOTE

- Sound is muted during video search, slow motion, still picture, frame advance and double speed playback.
- To avoid damage to the tape, your Product will resume normal playback after about 5 minutes of slow motion playback and still picture.
- If an NTSC tape and a PAL or MESECAM tape recorded in LP mode is played back in still picture, frame advance, slow motion, Double speed, or Video Search mode, the picture may have horizontal jitter and the top of the picture will be distorted, but this does not indicate VCR malfunction.

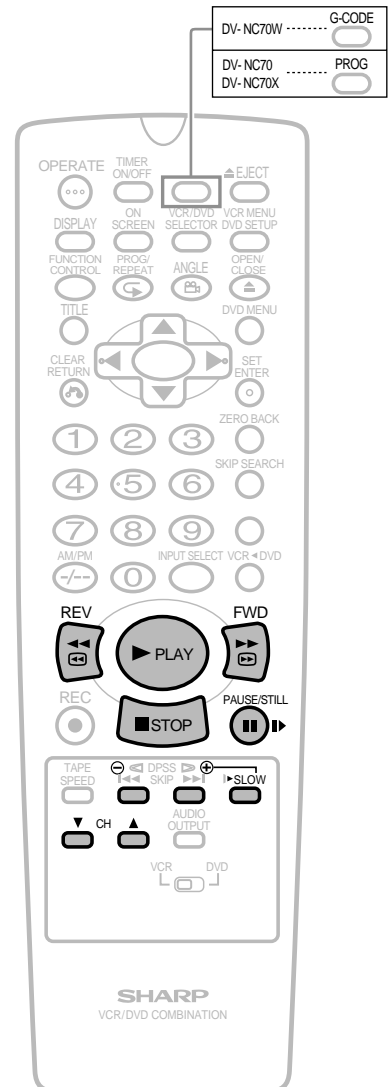
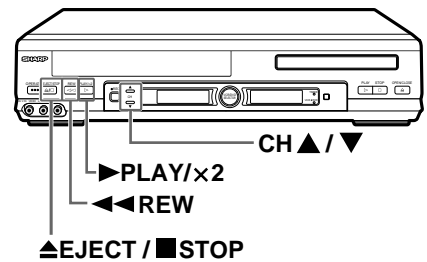



NTSC Tape Play Back on PAL TV

When you play back an NTSC tape on your Product, it is possible to use a PAL or multi-system compatible TV. However, please note the following:

- The picture will shrink vertically to some degree, as shown in the diagram, but this does not indicate a malfunction in your TV or Product.
- If your TV does not have a V-HOLD control, the picture may roll and be unwatchable. However, if you use a TV with a V-HOLD control, you can stop the rolling by adjusting the V-HOLD control and watch the picture.
- Horizontal noise bars may appear on the screen during special effect playback (video search, still, slow, frame advance, and double speed playback), possibly accompanied by discolouring.
- Although NTSC tapes can be played back into a PAL TV, those tapes cannot be dubbed by a PAL system VCR connected to the AUDIO OUT and VIDEO OUT terminals of this product. Tapes recorded in this way cannot be played back on PAL system VCRs.
- Set the Colour mode to AUTO or NTSC, and set the NTSC mode to PAL TV.



Full Auto Playback

(This function only works when AUTO RENTAL mode on the MODE selection screen is set to "OFF".)

Full Auto Playback lets you enjoy playback with ease. When you insert a cassette with the erasure protection tab removed, your Product automatically turns on the power and plays back the tape. When the tape reaches its end, the Product automatically rewinds the tape, ejects it and turns off the power. If a DVD is being played back, the power will not turn off.

NOTE

- If the erasure protection hole is covered, press ►PLAY after the power turns on automatically.

Auto Head Cleaning System

When the tape is inserted or ejected, this system automatically cleans the drum and heads with a special roller before recording or playback begins, protecting the heads and drum from dirt and preserving beautiful picture quality.

Auto Tracking Control System

This function automatically adjusts the tracking to match the recorded tape. Auto tracking engages in the following cases:

- When you insert the cassette and begin playback.
- When you press CH ▲ / ▼ at the same time.
- When the Product has been playing back an unrecorded section of tape, and then reaches a recorded tape segment.

When auto tracking engages, "▶" on the TV screen flashes for a few seconds.

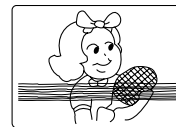

Poor Tracking

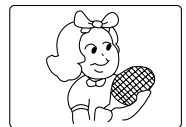

Normal tracking

NOTE

- When a poorly recorded tape is played back, auto tracking may not operate normally. In this event, manually adjust the tracking with CH ▲ / ▼ to make any noise disappear.

Quick Start with Full Loading Mechanism

Your Product has a standby function (Full Loading Mechanism) to allow immediate recording and playback. After pressing ●REC or ►PLAY, it takes about 2 seconds until recording or playback is engaged when in the standby mode.



AUTO RENTAL

(This function only works when AUTO RENTAL mode on the MODE selection screen is set to "ON".)

The convenient auto rental mode lets you enjoy playback with ease. When you insert a cassette with the erasure protection tab removed (rental videos, etc.), your Product automatically turns on the power, rewind the tape forward to find the recorded section, and plays back the tape. When the tape reaches the end of recorded section, the Product automatically rewinds the tape, ejects it and turns off the power. If a DVD is being played back, the power will not turn off.

- 1 Press **VCR MENU** to display the menu screen.
- 2 Press **▲ / ▼** to select "MODE".
- 3 Press **SET** to confirm.
- 4 Press **▲ / ▼** to select "AUTO RENTAL".

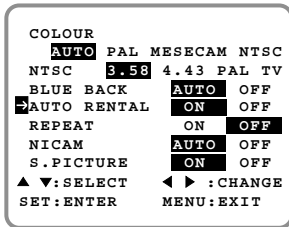

- 5 Press **◀ / ▶** to select "ON" or "OFF".
- 6 Press **SET** to confirm and then press **VCR MENU** to return to the normal screen.

NOTE

- If there is more than a 15 second unrecorded section between recorded sections, the tape will automatically stop and rewind. To watch the next recorded section, press **■STOP**, fast forward to that section and play the tape.
- If the erasure protection hole is covered, press **▶PLAY** after the power turns on automatically. (AUTO RENTAL Mode does not work.)
- The AUTO REPEAT mode has priority over the AUTO RENTAL mode. If the AUTO REPEAT mode is set to "ON" and the video cassette reaches its end, the Product will rewind the tape and play it back again without ejecting the tape or turning off the power.

COLOUR

If the quality of a colour recording is poor, the picture may turn black and white. In this event, set the COLOUR mode on the MODE selection screen to PAL (fixed PAL colour mode), MESECAM (fixed MESECAM colour mode), NTSC (fixed NTSC mode). Normally, the colour mode should be set to "AUTO" mode. (See "Mode Selection" on page 25.)

- 1 Follow steps 1 to 3 from "AUTO RENTAL" above.





2 Press ▲ / ▼ to select "COLOUR".

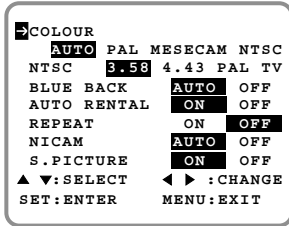

3 Press ◀ / ▶ to select "AUTO", "PAL", "MESECAM" or "NTSC".

4 Press SET to confirm and then press VCR MENU to return to the normal screen.

NOTE

- When the colour mode is set to fixed colour mode while the Product is playing back a black and white tape or is receiving a black and white broadcast, the picture may be coloured. In this event, set the COLOUR mode on the MODE selection screen to "AUTO" mode.

BLUE BACK

This function eliminates monitor noise and mutes sound during playback of unrecorded portions of a tape, and when receiving a non-broadcasting channel. A blue screen will also appear if the Product is set to the Auxiliary input (LINE IN) mode but no video signal is fed to the Product. (The BLUE BACK mode is set to "AUTO" at the factory.)

1 Follow steps 1 to 3 from "AUTO RENTAL" on page 55.

2 Press ▲ / ▼ to select "BLUE BACK".

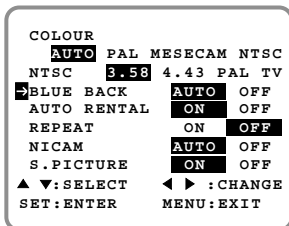

3 Press ◀ / ▶ to select "AUTO" or "OFF".

4 Press SET to confirm and then press VCR MENU to return to the normal screen.

NOTE

- Blue Back does not function during still picture, variable slow motion and video search.
- Blue Back may not function properly if the broadcast signal is too strong or too weak.
- Blue Back cannot be recorded.
- If the antenna signal is weak while recording a TV programme, or if the input signal is weak while tape dubbing, the monitor screen may turn blue since the Product may not recognize whether or not a proper signal is being received. In this event, set the BLUE BACK mode to "OFF".





Playback of Hi-Fi Recorded Tapes

This Product will play back both video and audio, or audio-only tapes recorded in the Hi-Fi mode.

NOTE

- Stereo sound output is only possible using the AUDIO OUT terminals. Sound from the radio frequency converter (RF OUT) is mono only. A blue screen will appear if audio-only Hi-Fi tapes are played back.

Audio Output Mode

The audio output mode is controlled by **AUDIO OUTPUT** on the Remote. The Product is normally set to the Hi-Fi mode, with **L** and **R** displayed on the VCR Front Panel display, and normal stereo sound output.

Select **L**, and only the Hi-Fi Left channel audio is heard from both the Right and Left speakers.

Select **R**, and only the Hi-Fi Right channel audio is heard from both the Right and Left speakers.

If you select the mono linear track, **L** and **R** will disappear.

NOTE

- Should the Hi-Fi output level be poor, the Product will automatically select the mono linear track output.
- When playing back tapes which have only Hi-Fi sound recorded: If Hi-Fi sound is not reproduced, or if there is some noise in the audio, press **CH ▲ / ▼** until the sound improves.

Adjusting Hi-Fi Audio Tracking

(To adjust the Hi-Fi tracking manually when playing back a poorly recorded Hi-Fi tape.)

- Normally you can simultaneously press and hold both **CH ▲ / ▼** to obtain the optimal Hi-Fi audio tracking.
- If Hi-Fi audio is unstable (frequent dropouts, etc.) with a rental video, a tape recorded on another VCR, restore normal tracking while playing back the tape as described below:

- 1 Press **ON SCREEN** on the Remote and select the Full Display mode. (See page 36.)
- 2 Simultaneously press **CH ▲ / ▼**.
- 3 Press **CH ▲ / ▼** repeatedly at equal, short intervals until the **L** and **R** indicators disappear from the On Screen Display (OSD).
- 4 Press **CH ▲ / ▼** in the same manner while counting button operations until the L and R indicators reappear and then disappear again.
- 5 Press **CH ▲ / ▼** again for half the number of times counted in step 4 above to obtain optimal track.



Sharp Super Picture

This function creates clearer picture quality only during playback.

- 1 Press **VCR MENU** to display the menu screen.
- 2 Select "MODE" with ▲ / ▼ and then press **SET** to confirm.

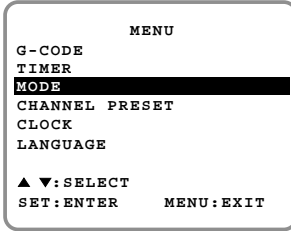

- 3 Select "S.PICTURE" with ▲ / ▼. Then set it to "ON" or "OFF" with ◀ / ▶.

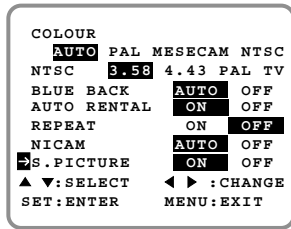

ON:

Normally leave the mode set to ON. This high picture quality function will create a clearer image during playback.

OFF:

Set to OFF when playing back a tape on the Product while editing or when strong noise appears on the screen.

- 4 Press **SET** to confirm and return to the menu screen.
- 5 Press **VCR MENU** to exit to normal screen.

NOTE

- This function only operates during playback. It will not operate when recording or watching a TV program with the VCR tuner.
- When playing S-VHS tape:
 1. Sharp Super Picture is set to off automatically. When finished playback, the setting will return to the previous setting.
 2. You cannot change ON/OFF setting manually.
- The ON/OFF status of the Sharp Super Picture can be checked when **ON SCREEN** is pressed to display OSD.
- When the Product power is turned off, the Sharp Super Picture setting is retained in memory.
- If power is interrupted for more than 60 minutes (power failure, etc.), the setting will return to ON.



Auto Repeat

With this feature, the entire tape is played back repeatedly.

- 1 Press **VCR MENU** to display the menu screen.
- 2 Select "MODE" with **▲ / ▼** and then press **SET** to confirm.

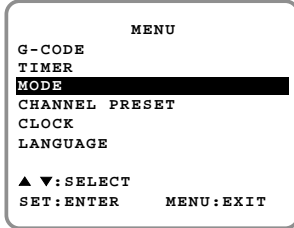

- 3 Select "REPEAT" with **▲ / ▼**. Then set the mode to "ON" or "OFF" with **◀ / ▶**.

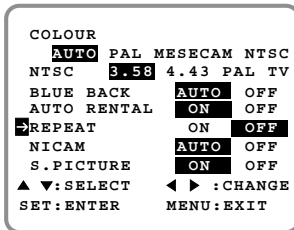

- 4 Press **SET** to confirm and return to the menu screen.
- 5 Press **VCR MENU** to return to normal screen.

DV- NC70W	G-CODE
DV- NC70	PROG
DV- NC70X	



NOTE

- "REPEAT" will be displayed on the OSD when the Auto Repeat mode is "ON".
- If the Auto Repeat is "ON" and the tape is rewinded to the beginning with rewind or reverse video search, the tape will automatically start playback.



Auto Zero Back

The zero-back function makes the cassette fast forward (or rewind) to the previously set "0:00.00" point and stop there.

- 1 Make sure the counter is displayed, then press **CLEAR** on the Remote at the point you wish to return and later "0:00.00" is displayed.
- 2 Press **ZERO BACK** on the Remote. The Product automatically detects the direction of the "0:00.00" position and fast forwards (or rewinds) the tape.
- 3 When the tape reaches the "0:00.00" position, the tape automatically stops.

NOTE

- The zero-back function does not operate during recording and fast forward (or rewind). The function works during the playback, stop and video search modes.





DPSS (Digital Program Search System)/Skip Search

DPSS

With this feature you can quickly locate a desired section of the tape. The DPSS feature makes use of index signals to search for a specified tape segment and begin playback automatically.

Index signal

An index signal is automatically recorded on the tape at the start of ordinary recording, simple recording timer and timer recording.

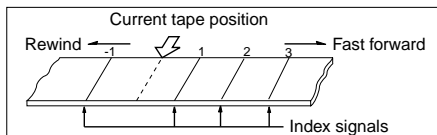

- 1 Load a tape containing index signals into the Product.
- 2 Select the index number of the desired programme using **DPSS** on the Remote. Search starts immediately. (When a signal is located, the displayed number decreases.)
- 3 When the selected index signal-encoded section is found, playback begins automatically.

NOTE

- DPSS may not function properly if the index signals are too close together (within 8 minutes of each other).
- DPSS can be cancelled with **▶PLAY** or **■STOP**.
- If the tape reaches its end or is rewinded completely before locating the desired index signal, DPSS is cancelled.
- DPSS may not function for damaged or worn tapes.
- The DPSS function cannot be used with tapes that contain no index signals.
- The starting point of a programme may vary slightly.
- DPSS does not operate during the slow, record, fast forward, rewind, timer standby, and timer recording modes, or when there is no cassette loaded.

Skip Search

When **SKIP SEARCH** on the Remote is pressed during playback mode, the product will perform a forward video search for a fixed interval of playback time before resuming playback. Depending on how many times the button is pressed, it is possible to set the forward video search time to approx. 30, 60, 90 or 120 seconds of recorded material.

Number of Times Pressed	Forward Video Search Time
1 time	Approx. 30 sec. (of playback time)
2 times	Approx. 60 sec. (of playback time)
3 times	Approx. 90 sec. (of playback time)
4 times	Approx. 120 sec. (of playback time)

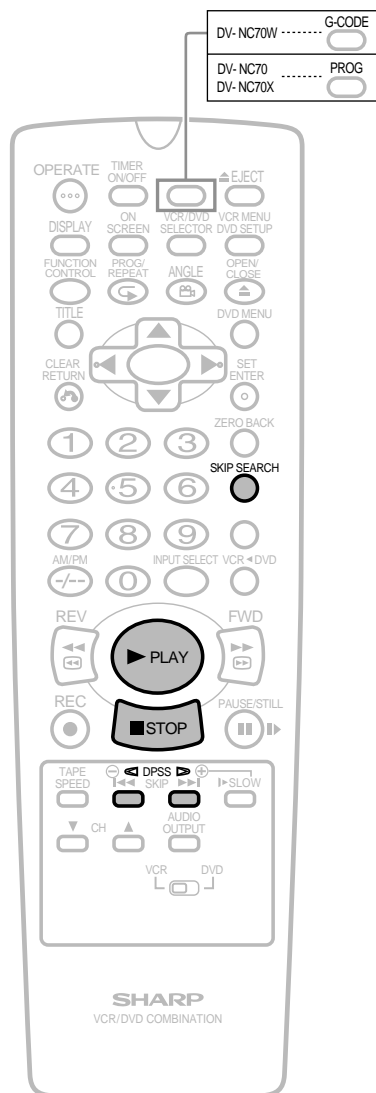

TV Programme Recording

Cassette Erase Protection

A **VHS**, **VHS** cassette has a removable tab to prevent accidental erasure of recorded material. Removing the tab prevents recording. To record on a video cassette with the tab removed, place adhesive tape over the tab opening.

Recording a TV Programme

Preparation

- Press **OPERATE**. Then move the **VCR/DVD CHANGE Switch** to **VCR**.
- Ensure the Video channel is selected on the TV.

- 1 Insert the cassette, making sure the erasure protection hole is covered.
- 2 Select the channel position you wish to record with **CH ▲ / ▼**.
- 3 Select the SP (Standard Play), EP (Extended Play) or LP (Long Play) recording speed with **TAPE SPEED** on the Remote ("SP", "EP" or "LP" will light up on the VCR Front Panel display.) SP (Standard Play) gives the best picture quality, EP (Extended Play) gives the triple recording time and LP (Long Play) gives the double recording time.

NOTE

- If the **COLOUR** mode is set to "AUTO" or "MESECAM", when a SECAM signal is received and the EP mode is selected, the Product will automatically change the EP mode to LP mode.
- 4 Press **REC**. (If the erasure protection hole is uncovered, the cassette will be ejected.) To pause during recording, press **PAUSE/STILL**. To resume recording, press **PAUSE/STILL** again.
 - 5 To stop recording, press **STOP**.

NOTE

- The pause mode disengages automatically after about 5 minutes, and the Product enters stop mode.
- To record audio and video from an external source through the **AUDIO/VIDEO** terminal on the rear of the Product, press **INPUT SELECT** on the Remote to select the AV channel position situated between the last channel and first channel. (When the AV position is selected, "L1" or "L2" is displayed where a channel position number is usually displayed.)
- If the TV signals are weak and the picture changes to monochrome, set the strict colour mode on the **MODE** selection screen. (See "Mode Selection" on page 23.) Normally, the colour mode should be set to "AUTO".

To Watch Another TV Programme While Recording

After steps 1 to 4 have been completed, select the programme you wish to view using the TV tuner. At the end of the tape, your Product will automatically stop recording, rewind the tape, eject it and then turn off the power. If a DVD is being played back, the power will not turn off.

ERASURE PROTECTION TAB

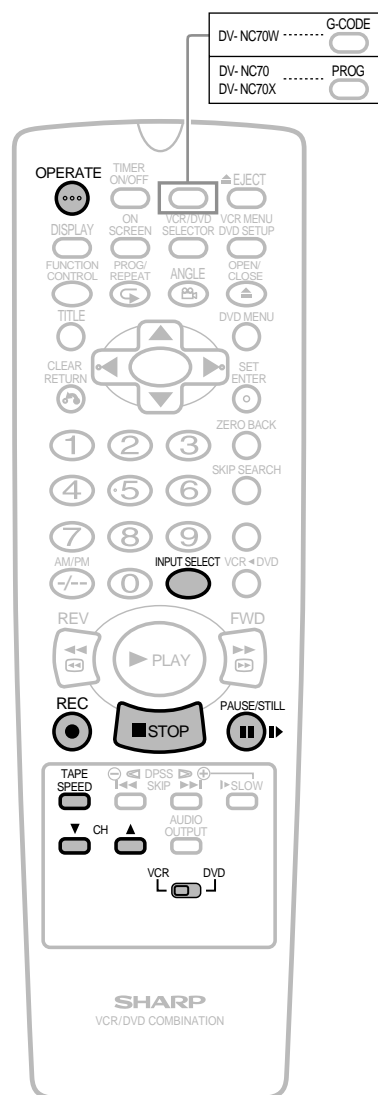
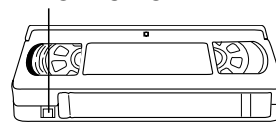



Recording NICAM/IGR Multiplex Broadcasts

This Product is capable of receiving NICAM multiplex broadcasts (PAL-I, B/G, D/K) and IGR multiplex broadcasts (PAL-B/G, D/K). NICAM multiplex broadcasts will be recorded in stereo/bilingual when the NICAM setting on the OSD's MODE is set to AUTO. For information on how to carry out NICAM setting (See "Mode Selection" on page 25). IGR multiplex broadcasts will be recorded on stereo/bilingual. (The AUTO/OFF setting will not function.) This Product automatically records on two types of audio track.

Hi-Fi track:



Special rotary heads will be used to record an audio signal deep in the video track in Hi-Fi. Multiplex broadcasts fall into "stereo" and "bilingual" broadcasts and they will be automatically recorded on their respective tracks.



Normal track:

Conventional analogue audio is always recorded on the normal track (mono sound) regardless of whether your Product is receiving a multiplex broadcasts or not.

Setting of "NICAM" in MODE Broadcast	AUTO position		OFF position	
	Hi-Fi track	Normal track	Hi-Fi track	Normal track
Normal sound (mono sound)	mono sound	mono sound	mono sound	mono sound
NICAM (bilingual)	NICAM sound (bilingual)	mono sound	mono sound	mono sound
NICAM (stereo)	NICAM sound (stereo)	mono sound	mono sound	mono sound
IGR (bilingual)	IGR sound (bilingual)	mono sound	IGR sound (bilingual)	mono sound
IGR (stereo)	IGR sound (stereo)	mono sound	IGR sound (stereo)	mono sound

On screen display

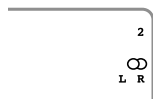
- When receiving a stereo multiplex broadcast,  (LR) will be indicated on the on screen display.
- When receiving a bilingual multiplex broadcast,  will be displayed on the on screen display.

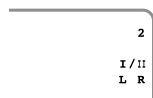
Broadcast TYPE	NICAM	IGR
Stereo		
Bilingual		

NOTE

- There are tapes, though small in number, which have a normal track that has been divided into two tracks. On such tapes, stereo as well as bilingual audio are recorded on the normal track. If such a tape is played back on your Product, the tape's stereo sound will be reproduced in monaural and its bilingual in both languages combined.
- When a cassette tape on which a NICAM multiplex broadcast has been recorded in stereo or bilingual mode is played back by a VCR that is not a Hi-Fi VCR, only the sound on the normal track will be reproduced.
- When you select "OFF" for NICAM in the OSD MODE, the stereo and bilingual audio of a NICAM multiplex broadcast will be fixed to the normal sound.

Simple Recording Timer

Immediate Recording

This is convenient function when having an unexpected visitor or telephone call.

- 1 Select the channel position to be recorded with **CH ▲ / ▼**.
(Example) Channel position 2

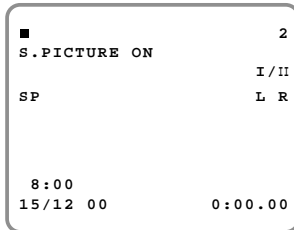

- 2 Press **●REC** to enter the normal recording mode. Then, press **●REC** repeatedly to set the desired ending time.
(Example) Ending time 9:30

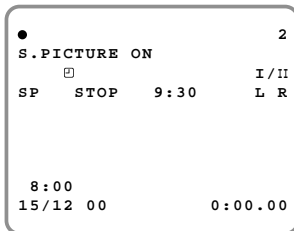

DV-NC70W	G-CODE
DV-NC70	PROG
DV-NC70X	



NOTE

- Each press of **●REC** increases the stop time by 10 minutes.
- Press **■STOP** to terminate recording.



Programming the Timer with G-CODE® System (DV-NC70W only)

This product has the G-CODE programming system. By simply inputting the G-CODE number with the number buttons, you can programme your Product timer recording.

The G-CODE numbers are listed in most newspaper, TV guide, and local cable TV listings.

The timer can be set for automatic recording of up to 8 events over a 365 day period. In addition, each of the events can be set to be recorded on a daily or weekly basis up to the limit of the tape.

Preparation

- Load the cassette, ensuring the erasure protection hole is covered. The Product power will automatically turn on.
- Check that the clock is displaying the correct time.

- 1 Press **VCR MENU**. Then select "G-CODE" with ▲/▼ and press **SET** to confirm.

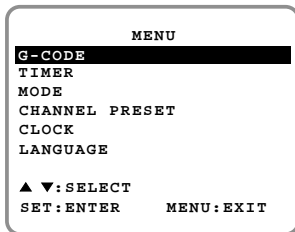

- 2 Set the G-CODE number with the number buttons (0 to 9).

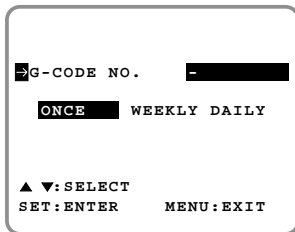

NOTE

- For the G-CODE number, refer to your newspaper or TV guide.
- Press the **G-CODE** button on the Remote to directly select this screen.

- 3 If you want to record only once, press **SET** and go to step 4. Otherwise, press ▲/▼ to select daily/weekly setting mode and select "DAILY" or "WEEKLY" with ◀/▶. Then press **SET** to confirm.

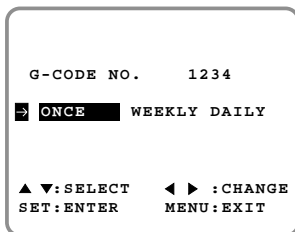

NOTE

- "ONCE": To record only once.
- "WEEKLY": To record every week at the same time.
- "DAILY": To record every day at the same time.





- 4** If you are going to record a programme from a station which does not have the PR number programmed, (" - " is displayed) set that number to be the same as the PR number to which your broadcasting channel is set into. (See Note on page 67.) Use the number buttons (0 to 9) or ▲/▼. Then press ►.
- (Ex.: 47)

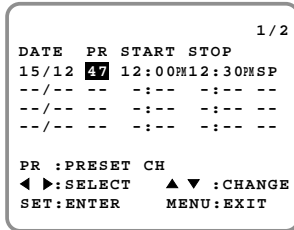

- 5** Select the tape speed with ▲/▼.

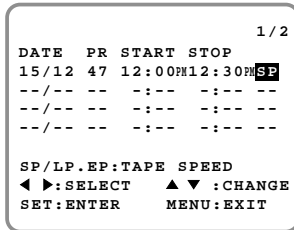

NOTE

- If the COLOUR mode is set to "AUTO" or "MESECAM", when a SECAM signal is received and the EP mode is selected, the Product will automatically change the EP mode to LP mode.
- A tape recorded in the PAL EP (Extended Play) mode can only be playback in a VCR which have its same function (PAL EP (Extended Play) mode).
- For best result, it is advisable to Playback or Recording EP mode with this Product.

- 6** Press SET.

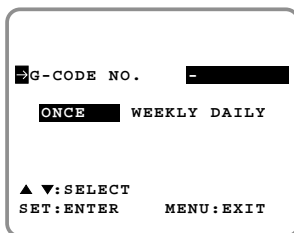

NOTE

- To programme additional timer settings, press SET and repeat steps 2 and 6.





7 Press **VCR MENU** to return to the normal screen.

8 To set the product for automatic timer recording, press **TIMER ON/OFF** and ensure the “” lights on the VCR Front Panel display.

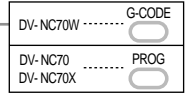
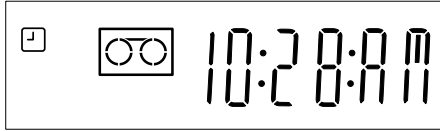

- NOTE**
- Please be sure to check that the start and end times of two different programmes do not overlap, as the remote control has been designed to accept the basic individual G-CODE number only. If the recording periods of two programmes overlap, the beginning of the second programme will not be recorded.
 - To cancel the programmed G-CODE setting, select the TIMER setting mode on the menu screen. Then select the programme number you wish to cancel with **▲/▼** and press **CLEAR**. (See “Cancelling Timer Programmes” on page 72.)

Setting the Programme Number In Step 4

When using the G-CODE system for the first time the Programme number (PR) on the screen shows two dashes and is highlighted white. Set it to be the same as the PR number to which your broadcasting channel is set into.

For instance if you can view CH 47 on programme (PR) 47, set the On screen PR number to 47.

- You need to set this only once.
- If the channels are returned you need to set the PR numbers again.

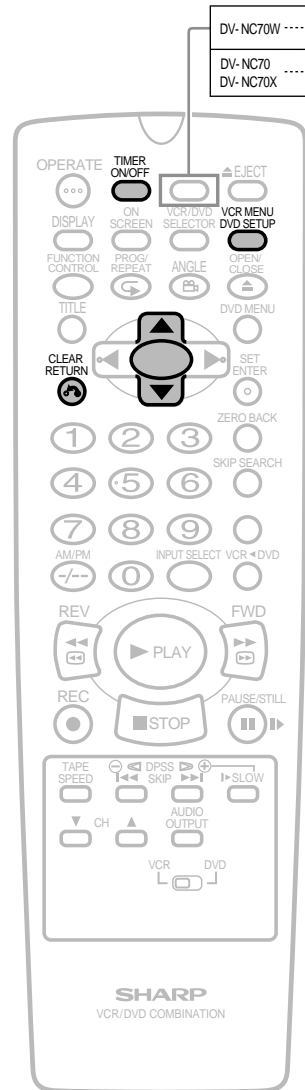
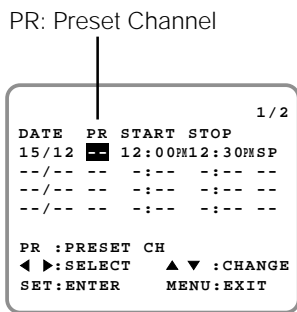

Recording with the Timer

The timer can be set manually for automatic recording of up to 8 events over a 365 day period.

Preparation

- Load the cassette, ensuring the erasure protection hole is covered. The Product power will automatically turn on.
- Check that the clock is displaying the correct time. (See “Setting the Clock” on page 35.)
- Be sure that the colour mode is set to “AUTO”. (See “COLOUR” on page 55.)

For DV-NC70 and DV-NC70X model:
Press **PROG** on the Remote to enter the Timer setting screen.

- 1 Press **VCR MENU**. Then select “TIMER” with ▲ / ▼ and press **SET**.

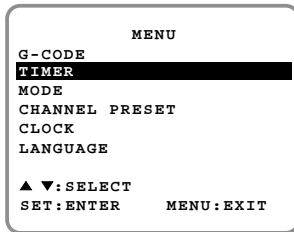

- 2 Select the timer position with ▲ / ▼ and press **SET**.
 - If the timer positions 1 to 4 have already been set, the screen changes to 2/2 (timer positions 5 to 8).

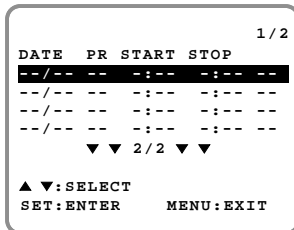

- 3 Set the date for timer recording with the number buttons (0 to 9) or ▲ / ▼ on the Remote and press **▶**.
 - First set the “day” digits and then “month”. If there is only one “day” or one “month” digit, enter a 0 first.

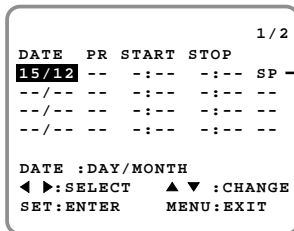

“SP” will be displayed automatically.





- 4 If you want to record only once, press **▶** and go to step 5. Otherwise, select "D (DAILY)" to record at the same time each day or "W (WEEKLY)" to record at the same time each week with **▲ / ▼**, and then pressing **▶**.

					1 / 2
DATE	PR	START	STOP		
15/12	---	----	----	SP	
--/--	--	----	----		
--/--	--	----	----		
--/--	--	----	----		
▶ : ONCE W : WEEKLY D : DAILY ▲ ▼ : SELECT ▲ ▼ : CHANGE SET : ENTER MENU : EXIT					

- 5 Set the channel number using the number buttons (0 to 9) or **▲ / ▼** and press **▶**.
- To record audio and video from an external source through an AUDIO/VIDEO terminal on the Product. Press **▲ / ▼** to select an AV channel. (When an AV position is selected, "L1" or "L2" is displayed where a channel position number is usually displayed.)

					1 / 2
DATE	PR	START	STOP		
15/12	47	----	----	SP	
--/--	--	----	----		
--/--	--	----	----		
--/--	--	----	----		

DV-NC70W	G-CODE
DV-NC70	PROG
DV-NC70X	

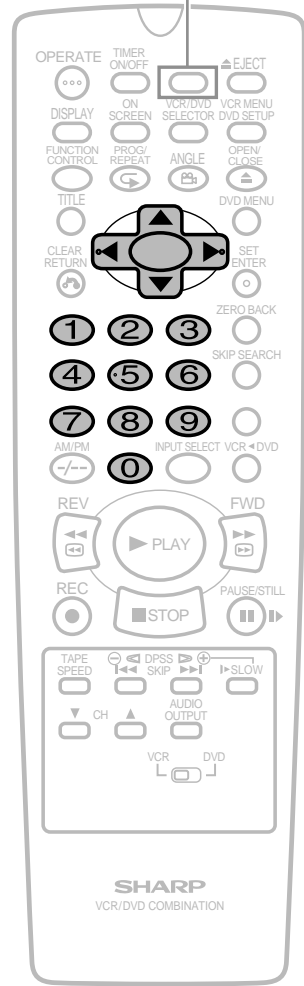

NOTE

- ▲ / ▼** can also be used to set the date and time instead of the number buttons (0 to 9).
- Press 0 first if the day, month, hour or minute is a single digit.

- 6 Set the start time with the number buttons (0 to 9) or **▲ / ▼** and press **▶**.

					1 / 2
DATE	PR	START	STOP		
15/12	47	12:00	----	SP	
--/--	--	----	----		
--/--	--	----	----		
--/--	--	----	----		

When the clock is set to 24H mode, AM/PM indicator will not appear

- 7 Set the stop time with the number buttons (0 to 9) or **▲ / ▼** and press **▶**.

					1 / 2
DATE	PR	START	STOP		
15/12	47	12:00	12:30	SP	
--/--	--	----	----		
--/--	--	----	----		
--/--	--	----	----		



8 Select the speed with ▲ / ▼.

DATE	PR	START	STOP	1 / 2
15 / 12	47	12 : 00	12 : 30	SP
-- / --	--	-- : --	-- : --	--
-- / --	--	-- : --	-- : --	--
-- / --	--	-- : --	-- : --	--

DV-NC70W	G-CODE
DV-NC70	PROG
DV-NC70X	

NOTE

- SP: Standard Play, LP: Long Play, EP: Extended Play

9 Press **SET**. To programme additional timer settings, repeat steps 3 through 8.

DATE	PR	START	STOP	1 / 2
15 / 12	47	12 : 00	12 : 30	SP
-- / --	--	-- : --	-- : --	--
-- / --	--	-- : --	-- : --	--
-- / --	--	-- : --	-- : --	--

▼▼ 2 / 2 ▼▼

CLEAR: CANCEL
▲▼: SELECT
SET: ENTER MENU: EXIT

10 Press **VCR MENU** to return to the normal screen.

11 To set the product for automatic timer recording, press **TIMER ON/OFF** and ensure the "☐" lights on the VCR Front Panel display.

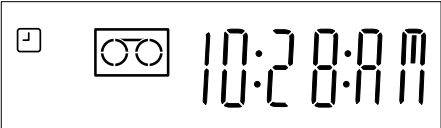

NOTE

- If the timer recording is finished, your product will stop and turn off automatically. (In this case the cassette is not ejected.)
If a DVD is being played back, the power will not turn off. (The timer recording is stopped while the power stays on.)
- If the cassette runs out during the timer recording, your product will eject the cassette without rewinding.
In this case, the timer recording is cancelled ("☐" disappears) and the device turns itself off automatically. However, if a DVD is being played back, the power will not turn off. (The power stays on.)
- If power is interrupted for more than 60 minutes (power failure, etc.), all timer settings will be cancelled.
- If **TIMER ON/OFF** is pressed when there is no cassette loaded, "☐" flashes for 5 seconds, indicating that timer recording is not possible.
- If **TIMER ON/OFF** is pressed while a cassette with an uncovered erasure protection hole is loaded, "☐" flashes and the cassette is ejected.
- When "☐" is lit, regular VCR operation, clock setting and setting/cancelling/confirming timer positions are not possible. For regular VCR operation, clock setting and setting/cancelling/confirming timer positions, press **TIMER ON/OFF** to disengage the timer ("☐" disappears), and then turn on your Product.
- During timer recording, the timer cannot be set.
- To terminate timer recording, press **STOP** during timer recording.
- If the same time is input for the start time and the stop time, the timer setting will be cancelled.





Confirming Timer Programmes

You can see on the On Screen Display a list of all timer programmes that are already set.

Preparation

- Press **OPERATE**. Then move the **VCR/DVD CHANGE Switch** to **VCR** and select the video channel on the TV.

- 1 Press **VCR MENU**. (If the “” indicator on the VCR Front Panel display is lit, cancel the timer standby mode with **TIMER ON/OFF** and then turn on the power.)
- 2 Select “**TIMER**” with **▲ / ▼** and then press **SET** to confirm .

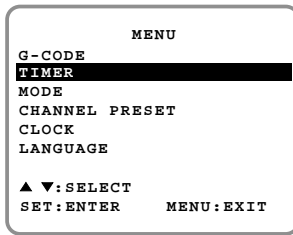

- 3 The screen for confirming programmes that have been set will appear.

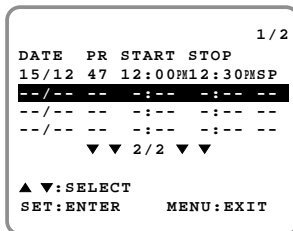

- Check the information displayed.
- If you want to correct the data, select the programme to be changed with **▲ / ▼** and press **SET**. Correct the setting as described on pages 72.

NOTE

- After the data is changed, press **SET** at the applicable tape-speed position at right.

- 4 Press **VCR MENU** to return to the normal screen.
 - After checking or correcting the programme contents, press **TIMER ON/OFF** to enter the Timer Standby mode.





Cancelling Timer Programmes

Perform the following procedure to cancel timer programmes that have already been set.

Preparation

- Press **OPERATE**. Then move the **VCR/DVD CHANGE Switch** to **VCR** and select the video channel on the TV.

- 1 Press **VCR MENU**. (If the "V" indicator on the VCR Front Panel display is lit, cancel the timer standby mode with **TIMER ON/OFF** and then turn on the power.)
- 2 Select "TIMER" with ▲ / ▼ and then press **SET** to confirm .

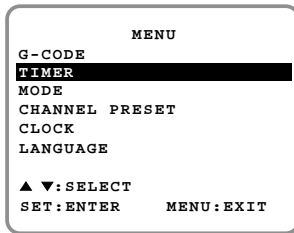

- 3 The screen for confirming programmes that have been set will appear.
 - Select the programme you wish to cancel with ▲ / ▼. (The selected programme will appear highlighted.)

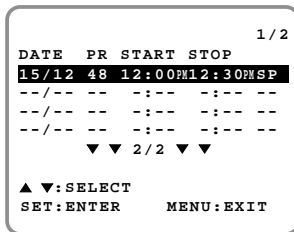

- 4 Double-check that it is the programme you wish to cancel, and press **CLEAR**. It will be cleared on the screen.

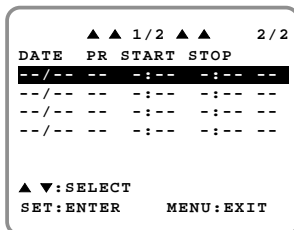

- 5 Press **VCR MENU** to return to the normal screen.
 - If there are still some programmes to be set, press **TIMER ON/OFF** to enter the Timer Standby mode.



Tape Dubbing

Tape Dubbing Connection Instructions

Your product can dub (copy) video material from another video device. It can also output video and audio signals for recording on other video or audio equipment. Audio/Video dubbing cannot be done separately.

- 1 Switch your product to the auxiliary input by pressing **INPUT SELECT**. "L1" lights up on the VCR Front Panel display. (You can also use **CH ▲ / ▼**.)
- 2 Begin recording on the dubbing VCR and playback on the source VCR simultaneously.

NOTE

- When using special playback functions (still picture, video search, frame advance, and variable slow motion) during dubbing, a blue screen may appear. Set BLUE SCREEN mode on the dubbing VCR (for recording) to OFF. (See **Mode Selection** on page 25.)
- Use an RCA pin-type connection cable (not supplied with VCR, but supplied with VIEWCAM) to connect source VCR to dubbing VCR.
- Refer to the manual of the VCR connected to this product when dubbing a tape.
- You can also use the front AV jacks. Select "L2" (Aux. 2 input) by pressing **INPUT SELECT** twice.
- If source VCR is a monaural mode, connect the audio cable to "AUDIO-L" of the dubbing VCR.

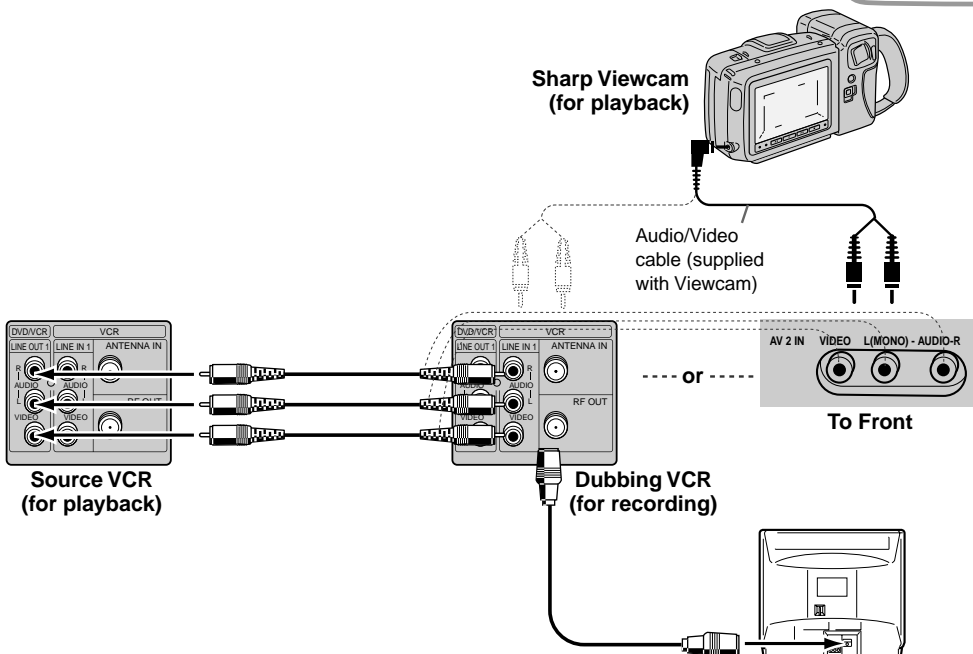



Recording a DVD Disc onto a Video Cassette

Use the following procedure to record the images and sounds on a DVD disc onto a video cassette.

Recording a DVD disc onto a Video cassette (Tape Editing mode)

Preparation

TV

- Turn on the TV and switch to the external "VIDEO" or "AV" channel.

This Product

- Press **OPERATE**.
- Move the **VCR/DVD CHANGE Switch** on the Remote to **VCR**.

1 Insert both the DVD disc and the video cassette for recording.

2 Press **VCR ◀ DVD**.
• The VCR ◀ DVD indicator lights up.

3 Move the **VCR/DVD CHANGE Switch** on the Remote to **DVD**.

4 Press **ON SCREEN** to turn off the DVD on screen display (See page 49).

5 Press **▶ PLAY**.
• The disc start playback.

NOTE

- In DVD to VCR recording mode, some discs cannot be recorded:
① Discs with copy guard function

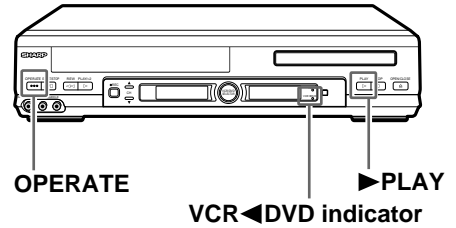



- 6** Press **●REC**.
- The images on the DVD disc are recorded onto the VCR cassette.

- When the VCR is in stop mode, the channel returns to the previously received channel.
- The **VCR/DVD SELECTOR** is fixed to VCR in the Tape Editing mode (VCR◀DVD indicator lights up).
- Operate the **VCR/DVD SELECTOR** after pressing **VCR◀DVD**, and after the Tape Editing mode has been cleared (VCR◀DVD indicator stops lighting up).

DV-NC70W	G-CODE
DV-NC70	PROG
DV-NC70X	

NOTE

- The following are not signs of trouble.
 - The brightness of images from regular DVD disc playback and from discs played in Tape Editing mode might vary.
 - The discs playing time and the Real time counter slightly vary when recording.
- The DVD/VCR output jacks become VCR fixed.
- The following operations cancel the DVD/VCR output and return to the regular external input.
 - Programming the timer.
 - Setting the recording ending time during Pause.
 - Turning **OPERATE** on or off after entering the Tape Editing mode.
- Copy protected DVD discs cannot be recorded (The image will be distorted, when **●REC** is pressed).
- If the DVD on screen display is "ON" while recording, the display will also be recorded.

The recordings, which you make from TV/radio broadcasts or audio sources (such as records) are for your own private use, and cannot be used without prior permission or consent of the author.

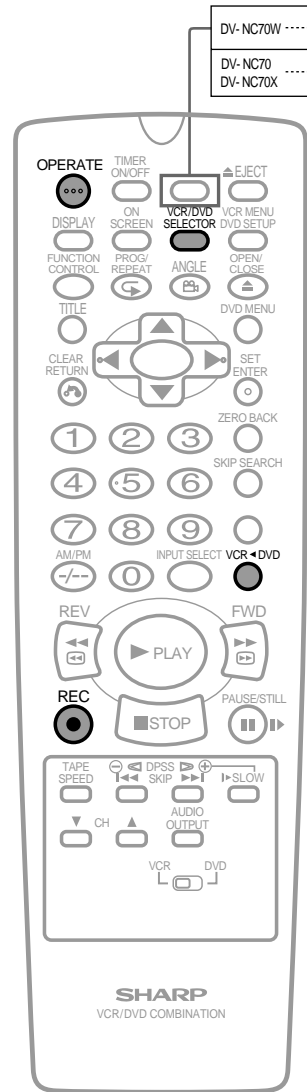

Watching the DVD

Preparing to Use DVD	78
When connecting a TV with the DVD output Jacks	78
When connecting a TV with the DVD/VCR shared output jacks	78
Playback	79
Basic Play	79
Track Direct Playback	79
Fast Forward/Fast Reverse	80
Slow-Motion Play	80
Still/Pause	81
Frame Advance	81
Skip (Forward/Reverse)	81
Angle Selection	82
Playing MP3 Discs	83
Regarding MP3 discs	83
Playing MP3 discs	83
To play MP3 discs	84
To play another file (music title) while playing	84
To skip the file while playing	84
About the Function Control Screen	85
Direct skip (title [track]/chapter/time)	86
Subtitle language setting	87
Angle setting	88
Audio setting	89
3D VIRTUAL SURROUND setting	90
DIGITAL GAMMA setting	91
Direct Selection of Scenes	92
Selecting Scenes by Title Number	92
Selecting Scenes from the Menu Screen	92
Programmed Playback	93
Chapter Programmed Playback	93
Track Programmed Playback	94
MP3 Files Programmed Playback	95
Repeat Playback	96
Repeat playback	96
A-B Repeat	97
Resume Function	98

Preparing to Use DVD

The following steps are necessary to display the DVD screen on the TV.

When connecting a TV with the DVD output jacks

- 1 Turn on the TV and switch the TV channel to the external input "VIDEO" or "AV" channel connected to DVD output jack.
- 2 Press **OPERATE**.
 - The start up screen is displayed on the TV screen.

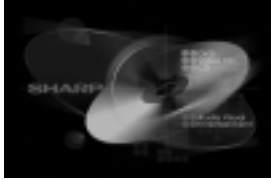
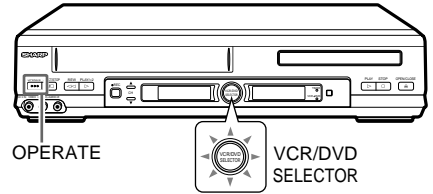

- 3 Move **VCR/DVD CHANGE Switch** on the Remote to **DVD**.

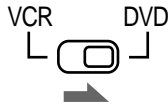

NOTE

- When the TV is connected to the DVD output jack, the image will be displayed regardless of the VCR/DVD mode selected. Therefore, it is not necessary to adjust the mode selected.

When connecting a TV with the DVD/VCR shared output jacks

- 1 Turn on the TV and switch the TV channel to the external input "VIDEO" or "AV" channel connected to DVD/VCR shared output jack.
- 2 Press **OPERATE**.
- 3 Move **VCR/DVD CHANGE Switch** on the Remote to **DVD**.
- 4 Press **VCR/DVD SELECTOR** to enter the **DVD** mode.
 - The VCR/DVD SELECTOR on the product lights up in green.

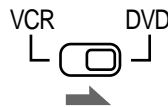

Light up in green

- Each time **VCR/DVD SELECTOR** is pressed, the mode changes between "VCR" mode and "DVD" mode.

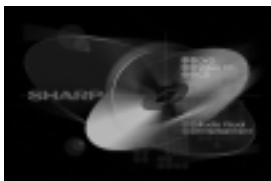

Preparation

- See **Preparing to Use DVD** on page 78.



- The icons below are used in this Operation Manual:
 - DVD** Indicates the functions that can be performed for DVDs.
 - CD** Indicates the functions that can be performed for AUDIO CDs.
 - CD-R/RW** Indicates the functions that can be performed for CD-R/RW.
 - VIDEO CD** Indicates the functions that can be performed for VIDEO CD.

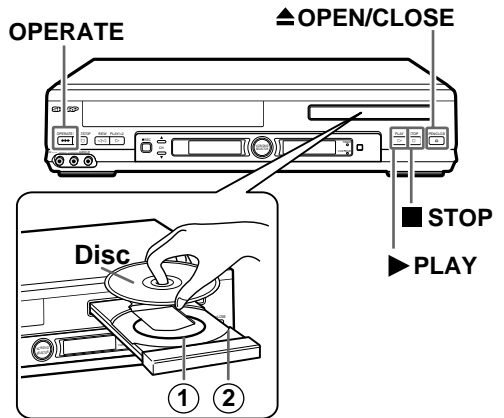

Basic Play

- 1 Press **OPERATE**.
- 2 Press **▲OPEN/CLOSE** to open the disc tray.
- 3 Place a disc onto the tray.
 - Hold the disc without touching either of its surfaces, position it with the printed title side facing up, align it with the guides, and place it in its proper position.
 - ① 8 cm (3") disc
 - ② 12 cm (5") disc
 - **Do not stack discs in the tray. This can damage the player and the discs.**
- 4 Press **▲ OPEN/CLOSE** to close the disc tray.
- 5 Press **▶PLAY**.
 - Playback image appears on the screen. (No image is shown for audio CDs.)
- 6 Press **■STOP** to stop playback.

Playing VIDEO CDs with Playback Control (PBC)

- Pressing **▶PLAY** begins PBC playback. Time display is not shown for some discs.
- If you specify the track number to be played (with playback stopped) and press **▶PLAY**, normal playback (not PBC playback) begins.

NOTE

- If the disc is loaded upside down or is damaged, "-----" appears on the DVD Front Panel display and the disc tray slides out.
- If you attempt to play a DVD disc with the wrong region code, "REGION CODE ERROR" appears on the TV screen and the disc tray slides out.



Track Direct Playback

- 1 To display the title number you want to watch, press the number buttons (**0** to **9**) on the Remote while playing or stopping an image.
- 2 Press **▶Play**.
 - The track number you entered in step 1 is played.

DV-NC70W	G-CODE
DV-NC70	PROG
DV-NC70X	

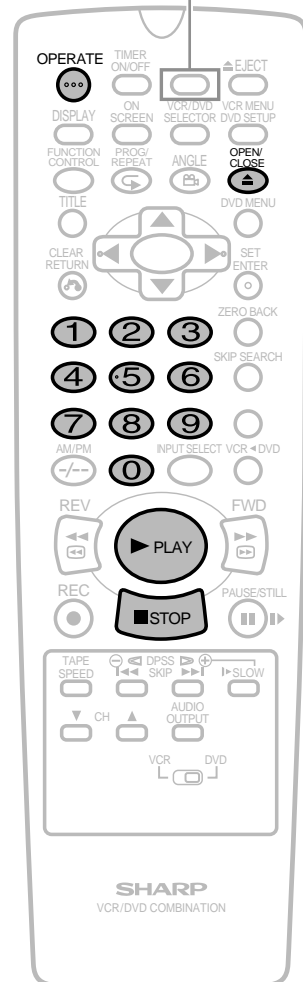



Fast Forward/Fast Reverse

- 1 Press **FWD** or **REV** during playback.
 - The disc begins fast scan at $\times 2$ speed (1).

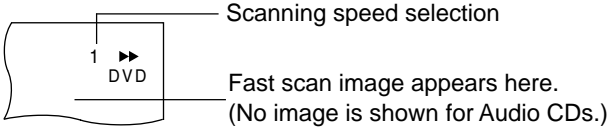

- Three speeds are available for DVD, VIDEO CDs and Audio CDs. Each time **FWD** or **REV** is pressed, the speed of fast scan changes in the following sequence:

→ 1 (about $\times 2$) → 2 (about $\times 8$) → 3 (about $\times 32$) →

- 2 Press **PLAY** when you reach the desired point.

NOTE

- On some discs, the fast scan function is disabled.
- On DVD discs, audio and subtitles are not played back during the fast scan playback. Audio is played back only when the search speed of the fast forward is 1 (about $\times 2$).
- With a DVD disc, you cannot search past a title. Playback starts from the beginning of the title.
- Depending on the audio equipment, the sound may not come out when the fast forward is 1 (about $\times 2$).

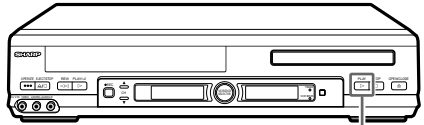

▶ PLAY

DV-NC70W	G-CODE
DV-NC70	PROG
DV-NC70X	

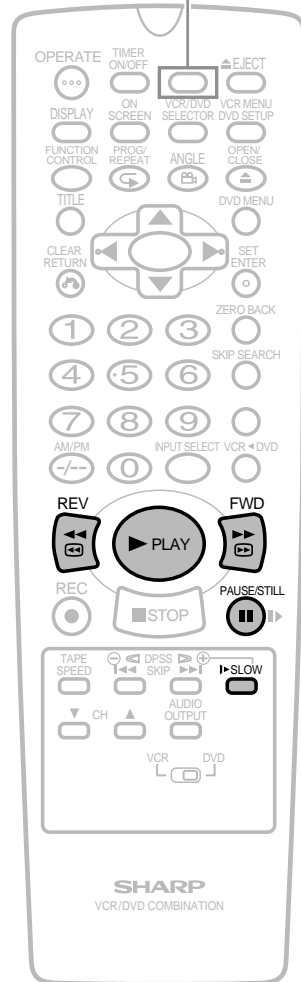

Slow-Motion Play

- 1 Press **SLOW** in the play mode or still mode.

- Three speeds are available. Each time **SLOW** is pressed, the speed of slow-motion playback changes in the following sequence:

(DVD)
→ 1 (about $\times 1/2$) → 2 (about $\times 1/8$) → 3 (about $\times 1/16$) →

- 2 Press **PLAY** to return to the normal playback or press **PAUSE/STILL** to return to the still picture mode.

NOTE

- On some discs, the slow-motion playback functions are disabled.
- Slow-motion playback is disabled on Audio CDs and MP3 discs.



Still/Pause

- 1 Press **II PAUSE/STILL** during playback.
- 2 If you press **▶ PLAY** while paused (STILL/PAUSE), normal playback resumes.

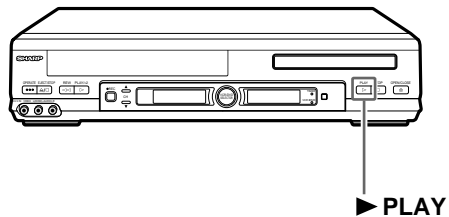

Frame Advance

- 1 Press **II PAUSE/STILL** during playback.
 - The playback is paused (STILL/PAUSE).
 - The disc goes forward by one frame each time **II PAUSE/STILL** is pressed.
- 2 Press **▶ PLAY** to return to the normal playback.



Skip (Forward/Reverse)

While you are playing a disc, this function jumps to the beginning of the next chapter/track (Forward) or the current chapter/track (Reverse) and automatically starts playing that chapter/track.

- 1 While a disc is playing, press **SKIP▶▶▶** or **◀◀◀SKIP**.
 - Playback skips forwards one chapter/track for each time **SKIP▶▶▶** is pressed.
 - If you press **◀◀◀SKIP** and playback begins, and you then press **◀◀◀SKIP** again within 3 seconds, playback returns to the beginning of the previous chapter/track.

DV-NC70W	G-CODE
DV-NC70	PROG
DV-NC70X	



NOTE

- The frame advance playback functions are disabled for audio CDs and MP3 discs.
 - On discs or titles that do not have chapter settings, playback skips forward to the next title or back to the beginning of the current title or disc.
 - On some discs, the skip functions are disabled.
 - The playback image is not displayed during the skip. It resumes during playback following the skip.
- When VIDEO CDs are played in PBC mode:
- Pressing **SKIP▶▶▶** causes the disc to move to the NEXT position.
 - Pressing **◀◀◀SKIP** causes the disc to move to the PREVIOUS position.



Angle Selection DVD

Some DVD discs contain scenes which have been shot simultaneously from a number of different angles. For these discs, the same scene can be viewed from each of these different angles. (The recorded angles differ depending on the disc used.)

- 1 While you are playing a DVD disc with different angles recorded, press **ANGLE** to view the number of the current angle.

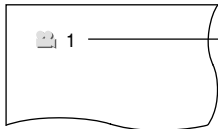

Number changes to show the number of the current angle. (The maximum number stipulated by the manufacturers is 9.)



Lights when different angles are recorded for the title currently playing.

- 2 Use **▲** or **▼** (or **ANGLE**) to change the scene to the next angle in those recorded.

- About two seconds later, playback continues from the new angle you selected.
- If no button is pressed within 10 seconds, playback continues without changing the current angle.

Sequence of angle shots (Example)

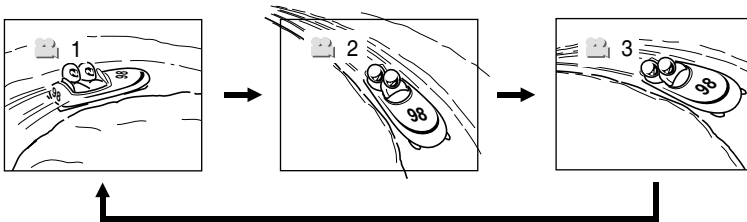

DV-NC70W	G-CODE
DV-NC70	PROG
DV-NC70X	



NOTE

- This function can only be used for discs on which scenes shot from multiple angles have been recorded.
- If no angles are recorded on the disc, xx is displayed.



Playing MP3 Discs

This product is able to play CD-R or CD-RW discs recorded in MP3 format.

Regarding MP3 discs

- MP3 files are audio data compressed in MPEG1 Audio layer 3 file format. "MP3 files" have ".mp3" as extensions. (Some files that have ".mp3" extensions or files that have not been recorded in MP3 format will produce noise or cannot be played.)
- Some discs cannot be played depending on the actual CD-R/CD-RW disc condition, the recording equipment and the disc's recording.
- Data on the CD-R or CD-RW disc, which has not been recorded in MP3 format, audio tracks or has been recorded in other file formats except MP3, cannot be played.

Playing MP3 discs

- Discs that have more than 255 folders and files in total cannot be played.
- Some MP3 files are not played in the order they were recorded.
- The number of layers, which can be recognized, including files and folders, is maximum 8.
- Only the first session of a multi-session disc can be played.
- When both audio tracks and MP3 files are recorded on a disc, audio tracks will be played.
- Depending on the folder tree, reading MP3 files can take time.
- The more files there are, the longer the reading time. Therefore it is recommended to lower the number of folders before recording.
- Folder or track (file) names are limited to 8 characters. The folder / file names are displayed in half-size, capital letters or half-size numbers. Folder or track (file) names that go over 8 characters will be abbreviated.
- Certain letters or symbols in folder names or file names may not be displayed. In this case, "?" will be displayed.
- The playing time may not be correctly displayed during MP3 file playback.
- It is recommended to record data at a lower speed as data recorded at fast speed can produce noise and may not be able to be played.

CAUTION

- It is impossible to make a digital copy by using a digital audio recording device which outputs sound from discs in MP3 format through the coaxial digital output jack of this product.



To play MP3 discs

- 1 Load the MP3 recorded CD-R or the CD-RW.
 - The folder selection screen will be displayed after the data is read.

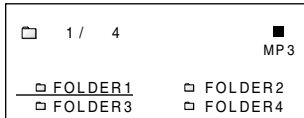

- 2 Select the folder you want to play by using ▲, ▼, ◀ or ▶ and then press **ENTER**.
 - The file (music title) in the folder is displayed on the file selection screen.

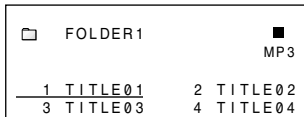

- Press **RETURN** to return to the folder selection screen.
 - When pressing ▶ **PLAY** after selecting the folder, the playback screen is displayed, and the files in that folder can be played from the beginning.
- 3 Select the file (music title) you want to play by using ▲, ▼, ◀ or ▶ and then press **ENTER**.
 - The chosen file (music title) will be played in sequence.

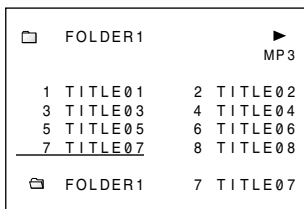

- 4 Press ■ **STOP** to stop play.

To play another file (music title) while playing

- 1 Press ▲, ▼, ◀, ▶ to select the file (music title) you want to play and then press **ENTER**.
 - The chosen file (music title) will be played.

NOTE

- The file where the cursor is on, will be played when the cursor is moved to a different from the file being played and no operation is taken within 10 seconds.
- Press **RETURN** to return to the folder selection screen.

To skip the file while playing

- 1 Press **SKIP** or **SKIP** during playback.
 - **SKIP** will skip forward, and **SKIP** will rewind.
 - When playing files (tracks) from other folders, press **RETURN** and then select the files from the folder selection screen.

While the MP3 disc is playing

- Time Search is disabled.
- Programmed playback is disabled.
- It is possible to repeat one track or the entire folder.

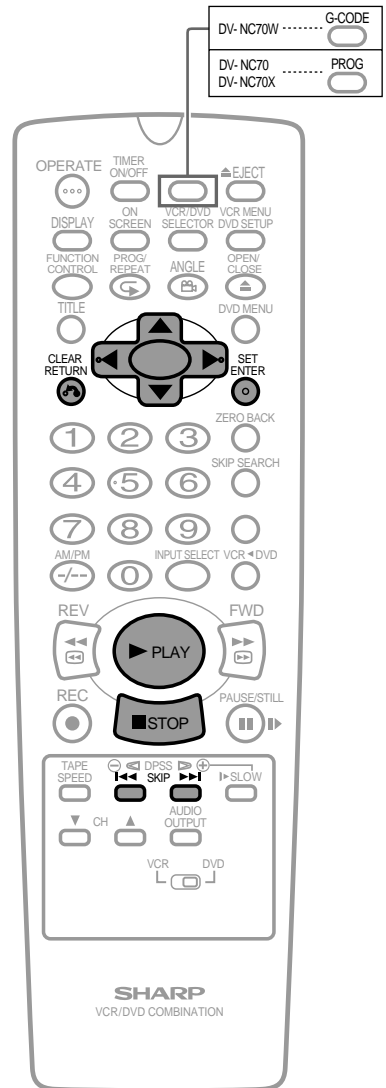

About the Function Control Screen

Using Function control, you can check at a glance and change the current settings of the following items: SUBTITLE, ANGLE, AUDIO, 3D VIRTUAL SURROUND and, DIGITAL GAMMA.

Function control also allows you three ways of direct skips (title [track], chapter and time).

- While the disc is playing, press **FUNCTION CONTROL** to display the screen shown below.
- Pressing **▲** or **▼** changes the currently selected item.
- Numbers in **■** refer to the pages where the setting procedures are described.

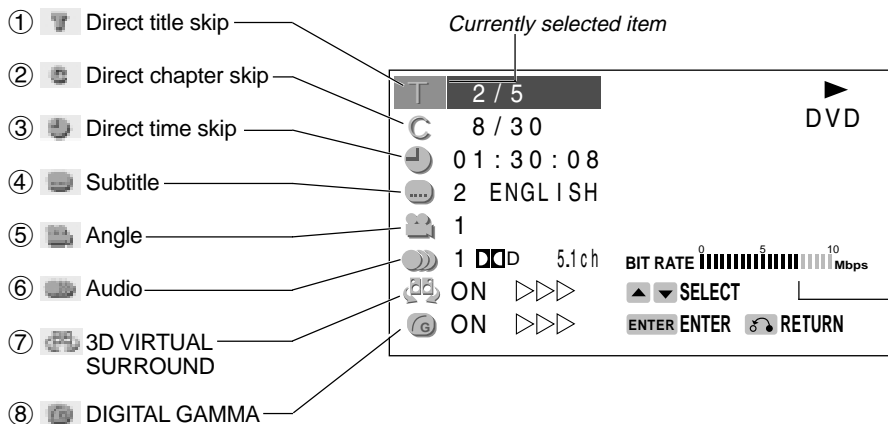

BIT RATE indicates the amount of data that is being transferred to the product per second. However, note that picture quality is not always in proportion to the bit rate.

1 Direct title skip **86**

- The number of the title currently played back is displayed.
- You can skip directly to the desired title.

2 Direct chapter skip **86**

- The number of the chapter currently played back is displayed.
- You can skip directly to the desired chapter.

3 Direct time skip **86**

- Elapsed time from the beginning of the disc is displayed.
- You can skip directly to the point from which you want to start playback.

4 Subtitle setting **87**

- The subtitle number and language currently selected are displayed. (When a disc with only one subtitle is played back, xx is displayed.)
- You can select the desired subtitle language.

5 Angle setting **88**

- The current angle is displayed. (When a disc with only one angle is played back, xx is displayed.)
- You can select the desired angle.

6 Audio setting **89**

- The type of audio currently selected is displayed.
- You can select the desired type of audio.

7 3D VIRTUAL SURROUND setting **90**

- This function provides rich surround sound by downmixing Dolby Digital 5.1 channel and Dolby Surround (Pro Logic) to 2-channel audio or TV.
- You can toggle the setting between "ON" and "OFF", and change the level.
- When "COMPRESSION" is "ON", this function is disabled, which is indicated by xx. To use the 3D VIRTUAL SURROUND function, set the "COMPRESSION" to "OFF" (see page 44).

8 DIGITAL GAMMA setting **91**

- You can make the entire image easier to see by brightening the darker and obscure portions.
- You can toggle the setting between "ON" and "OFF", and change the level.

NOTE

- In Function control mode, you can return to the previous setting screen by pressing **RETURN** or **FUNCTION CONTROL**.
- You can cancel the Function control mode by pressing **■STOP**, **DVD MENU** or **TITLE**.
- The setting screen is cleared automatically whenever you display a DVD screen that prompts you to change the scene by pressing **▲**, **▼**, **◀**, or **▶**.



DVD

C D

VIDEO
C D

Direct skip (title [track]/chapter/time)

Use the following procedure to perform the Direct title [track] skip, Direct chapter skip, or Direct time skip.

- 1 Press **FUNCTION CONTROL** during playback.
 - The Function control screen appears.

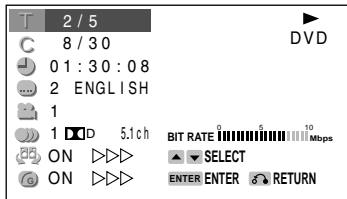

- 2 Use **▲** or **▼** to select **T** and then press **ENTER**.
(Example) Direct title skip

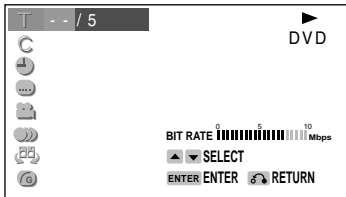

- 3 Use number buttons (**0** to **9**) to input the title number to which you want to skip.
 - You can also use **▲** or **▼** to input the title number.
 (Example) Entering title 5

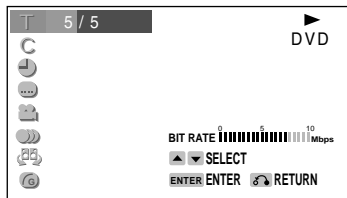

- 4 Press **ENTER**.
 - The played back image changes to the beginning of the specified title.
 - You can exit the Function control screen by pressing **RETURN** or **FUNCTION CONTROL**.

DV-NC70W	G-CODE
DV-NC70	PROG
DV-NC70X	



NOTE

- The number of titles, chapters or times you can input depends on that of the titles, chapters or times recorded on a disc you play.
- Direct chapter skip can only be used for DVD discs.



DVD

Subtitle language setting

Use the following procedure to perform the Subtitle language setting.

- 1 Press **FUNCTION CONTROL** during playback.
 - The Function control screen appears.

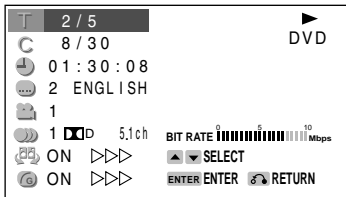

- 2 Use **▲** or **▼** to select and then press **ENTER**.

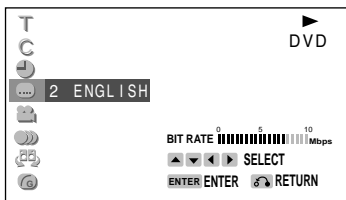

- 3 Press **▲** or **▼** to select the subtitle language you want to use.
 - You can set the subtitle setting to "OFF".
 - You can also toggle the setting between "ON" and "OFF" by pressing **◀** or **▶**.

(Example) Selecting "3 SPANISH"

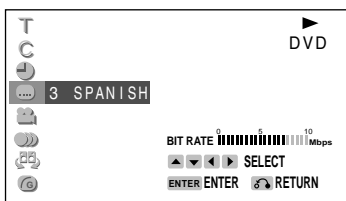

- 4 Press **ENTER** to confirm the setting.
 - You can exit the Function control screen by pressing **RETURN** or **FUNCTION CONTROL**.

DV-NC70W	G-CODE
DV-NC70	PROG
DV-NC70X	



NOTE

- This function can only be used for discs on which subtitles have been recorded in multiple languages.
- Some DVD discs are marked "Forced Display", indicating that the subtitling cannot be suppressed. With such discs, the subtitles will be displayed even when you select "OFF" display. This does not indicate a fault with this product.
- If no subtitles are recorded on the disc, [xx] is displayed.



DVD

Angle setting

You can change the angle of view when playing a DVD disc that contains scenes recorded from multiple angles.

Use the following procedure to perform the Angle setting.

- 1 Press **FUNCTION CONTROL** during playback.
 - The Function control screen appears.

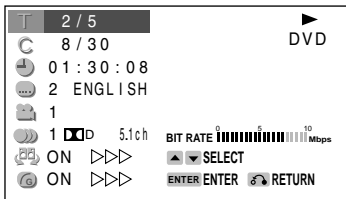

- 2 Use **▲** or **▼** to select and then press **ENTER**.

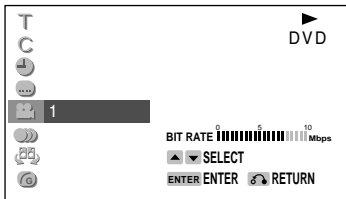

- 3 Press **▲** or **▼** to select the angle number you want.
 - The number of recorded angles differs depending on the disc used.

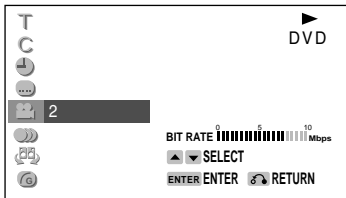

- 4 Press **ENTER** to confirm the setting.
 - You can exit the Function control screen by pressing **RETURN** or **FUNCTION CONTROL**.

DV-NC70W	G-CODE
DV-NC70	PROG
DV-NC70X	



NOTE

- This function can only be used for discs on which scenes shot from multiple angles have been recorded.
- If no angles are recorded on the disc, is displayed.



Audio setting

A number of different methods are used to record DVD audio onto a DVD disc, including multi-channels (used for voiceovers in other languages), Dolby Digital (5.1ch), DTS, and Linear PCM. This product provides a number of different audio modes from which you can choose to suit the type of disc you are playing.

Use the following procedure to perform the Audio setting.

1 Press **FUNCTION CONTROL** during playback.

- The Function control screen appears.

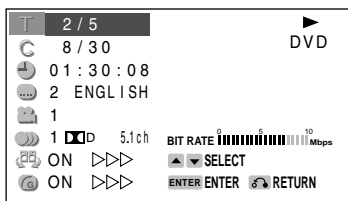

2 Use **▲** or **▼** to select and then press **ENTER**.

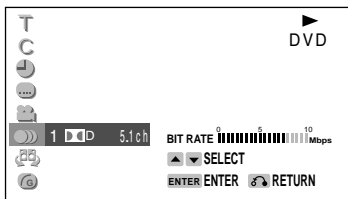

3 Press **▲** or **▼** to select the audio format you want to use.

- See page 44 for details about the types of audio format.

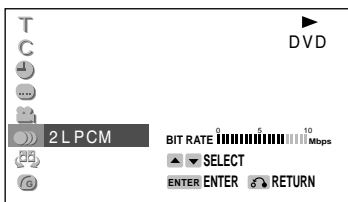

- When watching the video CD, the audio channels changes as the following sequence:

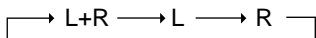

4 Press **ENTER** to confirm the setting.

- You can exit the Function control screen by pressing **RETURN** or **FUNCTION CONTROL**.

DV-NC70W	G-CODE
DV-NC70	PROG
DV-NC70X	



NOTE

- This function can only be used for discs on which the sound has been recorded in multiple formats.
- With certain types of discs, you can change the audio using the disc menu. (See page 44.)
- A DTS digital surround decoder is required to listen to DTS audio.



DVD

3D VIRTUAL SURROUND setting

This function allows you to enjoy a “surround sound” effect when you are using an analog connection (using AV 1 OUT on this product) to 2-channel audio equipment (TV, etc.).

Preparation

To use the 3D VIRTUAL SURROUND function

- Set the “COMPRESSION” setting in “AUDIO” to “OFF” (see page 44).

Refer to the table below about the types of audio format with which 3D VIRTUAL SURROUND works.

Types of audio recorded on the disc			
Dolby Digital	Dolby Pro Logic	Dolby Digital 2ch/Linear PCM	DTS
○	○	○	×

- 1 Press **FUNCTION CONTROL** during playback.
 - The Function control screen appears.

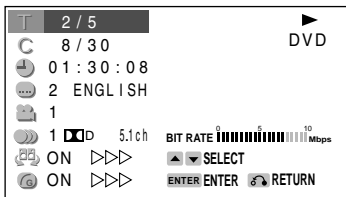

- 2 Use ▲ or ▼ to select and then press **ENTER**.

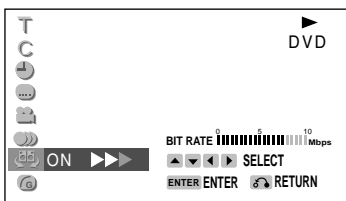

- 3 Press ▲ or ▼ to toggle 3D VIRTUAL SURROUND between “ON” and “OFF”.
- 4 While “ON” is selected, use ◀ or ▶ to change the level setting.

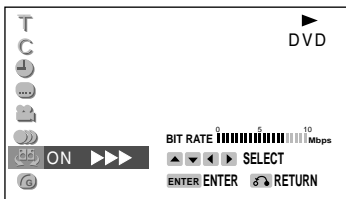

- 5 Press **ENTER** to confirm the setting.
 - You can exit the Function control screen by pressing **RETURN** or **FUNCTION CONTROL**.



NOTE

- 3D VIRTUAL SURROUND does not operate on Audio CDs.
- 3D VIRTUAL SURROUND does not operate when you set the “COMPRESSION” setting in “AUDIO SETUP” to “ON”.
- 3D VIRTUAL SURROUND does not operate when you are using a Digital connection.
- 3D VIRTUAL SURROUND does not operate when you playback a disc recorded using DTS format.



DVD

VIDEO
C D

DIGITAL GAMMA setting

DIGITAL GAMMA is a digital image quality enhancement function that gives a richer image by brightening the darker and more obscure portions of the image without altering the brightness of the brighter portions, thereby making the entire image easier to see. Three digital gamma settings are available to allow for differences in the images played and in brightness of the room.

- 1 Press **FUNCTION CONTROL** during playback.
 - The Function control screen appears.

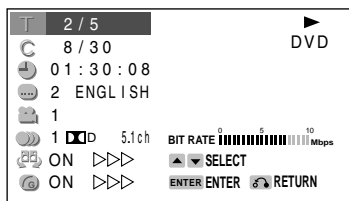

- 2 Use **▲** or **▼** to select **[GAMMA]** and then press **ENTER**.

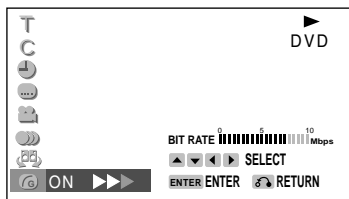

- 3 Press **▲** or **▼** to toggle DIGITAL GAMMA between “ON” and “OFF”.

- 4 While the “**[GAMMA]** ON” is displayed, press **◀** or **▶**.
 - The level selection indicator that shows the current level appears.

- 5 Use **◀** or **▶** to change the level.

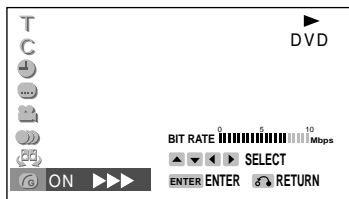

- 6 Press **ENTER** to confirm the setting.
 - You can exit the Function control screen by pressing **RETURN** or **FUNCTION CONTROL**.

DV-NC70W	G-CODE
DV-NC70	PROG
DV-NC70X	





Direct Selection of Scenes

DVD

Selecting Scenes by Title Number

- 1 Press **TITLE** to show the title screen.
(Example)

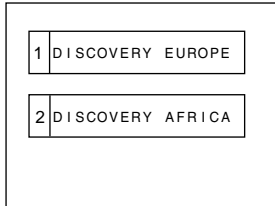

- 2 Use **▲**, **▼**, **▶** or **◀** to highlight the desired title.
- 3 When you press **ENTER** or **▶ PLAY**, the title specified in step 2 starts playing.

Selecting Scenes from the Menu Screen

- 1 Press **DVD MENU** to show the menu screen.
(Example)

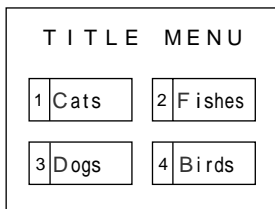

- 2 Use **▲**, **▼**, **▶** or **◀** to highlight the desired title.
(Example) Title 2 selected.

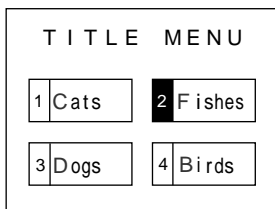

- 3 When you press **ENTER** or **▶ PLAY**, title 2 starts playing.

DV-NC70W	G-CODE
DV-NC70	PROG
DV-NC70X	



NOTE

- These functions only operate on DVD discs that have a title or menu screen.
- Languages not provided on the disc are not displayed.

Programmed Playback

The two types of programmed playback provided by this product are chapter programmed playback (DVD discs) and track programmed playback (Audio CD discs).

DVD

Chapter Programmed Playback

- 1 Press **PROG** while the disc is stopped.
 - The "DVD-VIDEO PROGRAM" screen appears.
 - Press **PROG** to return to the normal screen.

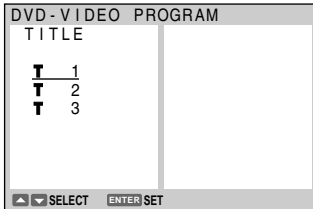

- 2 Press **▲** or **▼** to select the desired title and then press **ENTER**.
 - The chapter selection screen appears.

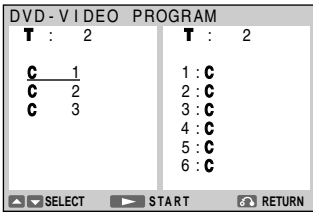

- 3 Press **▲** or **▼** to select the desired chapter and press **ENTER**.
 - The chapter is programmed in the playlist.

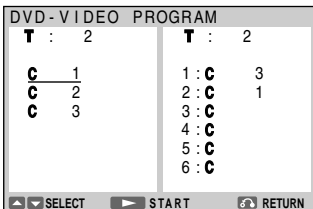

- Repeat the above step for each of the chapters that you want to play as part of the program.
 - To delete the chapter programmed in the playlist, follow the steps below.
 - ① Press **▶** to move the cursor to the playlist.
 - ② Press **▲** or **▼** to select the program (chapter) you want to delete and then press **RETURN**.
 - To delete all programmed chapters, move the cursor to the playlist and then press **RETURN** for more than two seconds.
- 4 Press **▶PLAY** to begin playing the programmed chapters.
 - The chapters will be played in the order they were entered.
 - The PROGRAM indicator lights up on the DVD Front Panel display.
 - 5 Press **■STOP** to stop programmed playback.
 - To start programmed playback again, follow the steps below.
 - ① Press **■STOP** to stop programmed playback.
 - ② Press **PROG**.
 - ③ Select the title you programmed and press **ENTER**. (If other titles are selected, the previously entered program will be cleared.)
 - ④ Press **▶PLAY**.

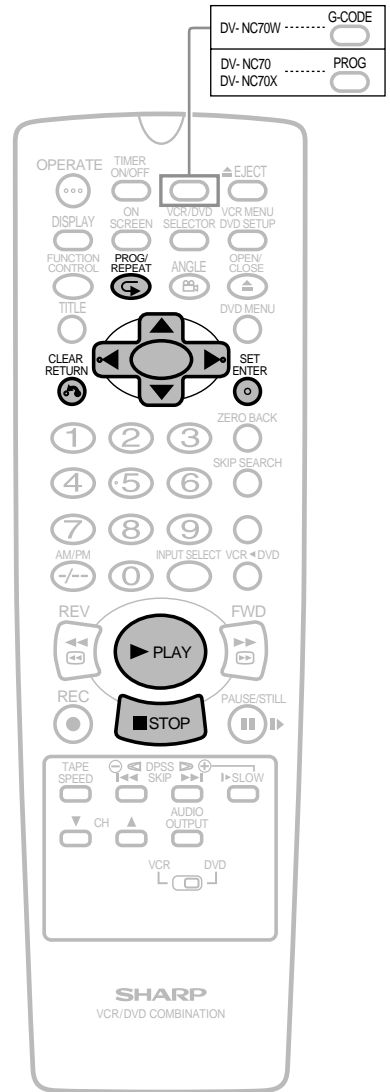

NOTE

- Up to 24 chapters can be programmed.
- Press **RETURN** to return to the previous screen.
- The program cannot be set during the normal playback.
- This function can only be used for DVD discs on which the chapter has been recorded.
- On some discs in which programmed playback is prohibited, this function is disabled.



Track Programmed Playback

- 1 Press **PROG** while the disc is stopped.
 - The "PROGRAM" screen appears.
 - Press **PROG** to return to the normal screen.

Example : CD PROGRAM screen

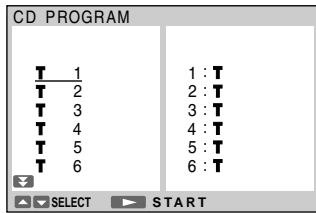

- 2 Press **▲** or **▼** to select the desired track and then press **ENTER**.
 - The track is programmed in the playlist.

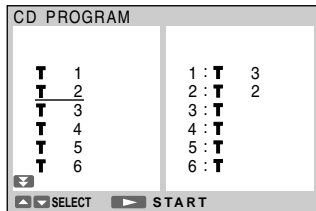

- 3 Repeat step 2 for each of the tracks that you want to play as part of the program.
- 4 Press **▶PLAY** to begin playing the programmed tracks.
 - The tracks will be played in the order they were entered.
- 5 Press **■STOP** to stop programmed playback.

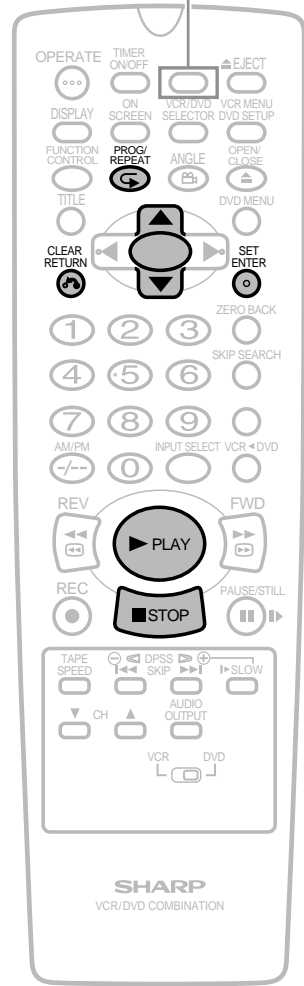

NOTE

- Up to 24 tracks can be programmed.
- Press **RETURN** to return to the previous screen.
- The program cannot be set during the normal playback.
- On some discs in which programmed playback is prohibited, this function is disabled.



CD-R/RW

MP3 Files Programmed Playback

- 1 Press **PROG** while the disc is stopped.
 - The "MP3 PROGRAM" screen appears.
 - Press **PROG** to return to the normal screen.

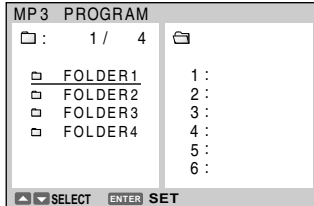

- 2 Press **▲** or **▼** to select the desired folder and then press **ENTER**.

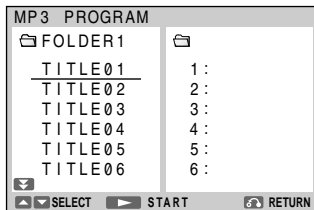

- 3 Press **▲** or **▼** to select the desired file and press **ENTER**.
 - The file is programmed in the playlist.
 - Press **RETURN** to return to step 2 and then select the files of other folder.

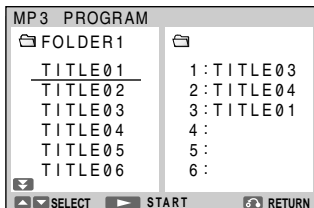

- Repeat the above step for each of the files that you want to play as part of the program.
- To delete the files programmed in the playlist, follow the steps below.
 - ① Press **▶** to move the cursor to the playlist.
 - ② Press **▲** or **▼** to select the program (track/file) you want to delete and then press **RETURN**.
- To delete all programmed chapter number, move the cursor to the playlist and then press **RETURN** for more than two seconds.

- 4 Press **▶PLAY** to begin playing the MP3 files.
 - The files will be played in the order they were entered.

- 5 Press **■STOP** to stop programmed playback.
 - To start programmed playback again, follow the steps below.
 - ① Press **■STOP** to stop programmed playback.
 - ② Press **PROG**.
 - ③ Select the file you programmed and press **ENTER**.
 - ④ Press **▶PLAY**.

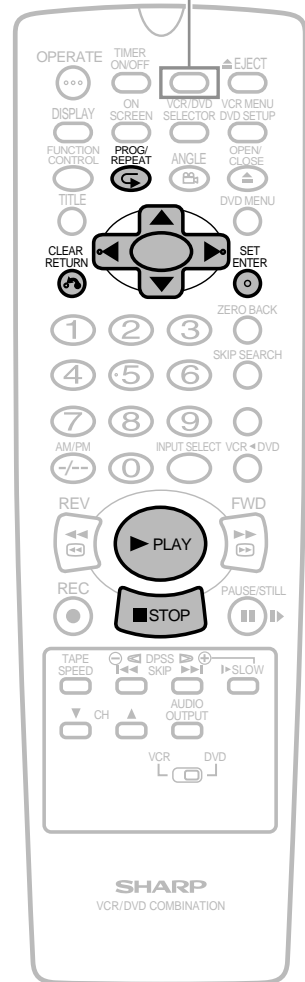
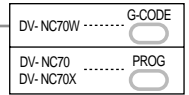

NOTE

- Up to 24 chapters can be programmed.



Repeat Playback

DVD

C D

CD-R/RW

VIDEO
C D

Repeat playback

- Press **REPEAT** while a disc is playing.
 - The "C" indicator appears on the DVD Front Panel.
 - Each time **REPEAT** is pressed, the repeat function changes as follows.
 - Depending on the disc type, the repeat function will vary.

DVD

Chapter Repeat

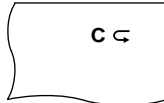

Title Repeat

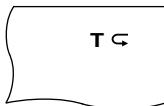

A-B Repeat
(See the next page for details.)

OFF

C D

**VIDEO
C D**

Track Repeat



Repeat all files in the disc



A-B Repeat
(See the next page for details.)

OFF

CD-R/RW

(Only MP3 File Format)

Repeat one file

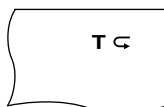

Repeat all files in the folder



OFF



- Press **ENTER** to start repeat playback.
 - Press **REPEAT** and select OFF when returning to regular playback.

NOTE

- Repeat playback is disabled on some discs.
- Repeat playback cannot be used during programmed playback.



A-B Repeat

A-B repeat allows you to repeat specified section on the disc.

- 1 Press **↶(REPEAT)** three times while a disc is playing.
- 2 While you are playing a disc, press **ENTER** when you reach the start of the section to be repeated.
- 3 While the disc is playing the same chapter/track, press **ENTER** again when you reach the end of the section to be repeated.

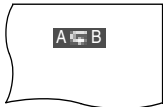

- The A-B repeat begins from the point where you specified in step 2.
- Press **↶(REPEAT)** to turn off the "↶" indicator when returning to regular playback.

NOTE

- To cancel A-B repeat, press **■ STOP**, **TITLE** or **DVD MENU**.
- A-B repeat can only be used within the same title/track. (On some DVD discs, A-B repeat is restricted to the same chapter.) If the title/track finishes before specifying the ending location (B), the location where the title/track finishes will be set as the ending location (B).
- The A-B repeat function cannot be used during programmed playback.
- If the DVD Front Panel display does not show the elapsed playback time while a disc is playing, A-B repeat playback cannot be used for that disc.
- The A-B repeat function does not operate in scenes where different camera angles are recorded.
- The A-B repeat function cannot be used on VIDEO CDs with PBC mode playback.
- Repeat playback cannot be used during programmed playback.





Resume Function

DVD

C D

VIDEO
C D

This function enables you to resume the playback from the location you specify.

- 1 Press **■STOP** at the desired point during playback.
 - "RESUME" appears followed by "RESUME" on the screen.
 - This product stores the location where you stopped.

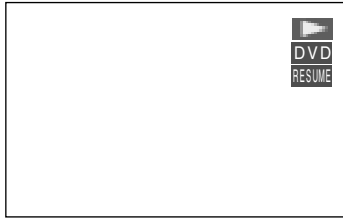

- 2 Press **▶PLAY** to restart play.
 - Play resumes from a point slightly before the point where it was stopped.
 - Press **▶PLAY** to resume disc play, if auto-playback starts from the beginning of the disc when you reload the same disc after removing it.

NOTE

- Resume information will not be cancelled even if the power is turned off.
- The continued playback described here may not be possible on some discs (such as discs that automatically start playing when the disc tray closes).
- The resume operation does not work in the following cases
 - VIDEO CDs with PBC mode playback.
 - MP3 file playback.

This resume operation is cancelled in the following cases.

- If you press **■STOP** twice.
- If you press **■STOP** during auto-playback.
- When you open the disc tray.
- After enabling the Resume function.





Troubleshooting

The following problems do not always denote a malfunction of this Product. Perform the checks listed below before calling service.

■ VCR/DVD

Problem	Suggested Solution
<ul style="list-style-type: none"> No power 	<ul style="list-style-type: none"> Is the power cord connected properly? Is the power cord firmly plugged into the power outlet? One of the safety mechanisms may be operating. In this event, unplug the Product from the power outlet briefly and then plug it in again.
<ul style="list-style-type: none"> The Remote does not work. 	<ul style="list-style-type: none"> Are the batteries loaded correctly? Are the batteries flat? Is the signal emitter on the Remote pointing at the Product? Is the Remote too far from the Product, or is there any obstacle between the Remote and the Product? Did the VCR/DVD CHANGE Switch change correctly?
<ul style="list-style-type: none"> No picture 	<ul style="list-style-type: none"> Did the VCR/DVD SELECTOR change correctly?
<ul style="list-style-type: none"> DEW 	<ul style="list-style-type: none"> See page 2 for information (Condensation).

■ VCR

Problem	Suggested Solution
<ul style="list-style-type: none"> VCR does not record. 	<ul style="list-style-type: none"> Cassette erasure protection tab has been removed. Use a different cassette or place adhesive tape over the tab opening. Check if a cassette is loaded.
<ul style="list-style-type: none"> Cassette is automatically ejected when pressing ●REC or TIMER ON/OFF. 	<ul style="list-style-type: none"> Cassette erasure protection tab has been removed. Use a different cassette or place adhesive tape over the tab opening.
<ul style="list-style-type: none"> No colour or poor TV picture during normal viewing. 	<ul style="list-style-type: none"> Make sure all the cables are correctly connected. Make sure the Product power cord is properly plugged in. Set the COLOUR MODE, NTSC MODE, and SYSTEM modes to match the broadcast system and TV.
<ul style="list-style-type: none"> Snowy picture appears on TV during playback. 	<ul style="list-style-type: none"> Press CH ▲ / ▼ to adjust the tracking or try a different cassette. The heads may be contaminated with condensed moisture or magnetic coating from the video tape. (If this is the case, the heads need to be cleaned. Ask the retailer or a Sharp approved service centre.) This Product has a built-in full auto head cleaning mechanism, however, there are some environments in which head cleaning cannot be carried out completely.
<ul style="list-style-type: none"> No tape movement. 	<ul style="list-style-type: none"> Make sure the Product is not in pause/still mode. Make sure the tape has not reached the beginning or end.
<ul style="list-style-type: none"> Cannot receive NTSC (M) broadcasting. 	<ul style="list-style-type: none"> Make sure that the B/G, I, D/K, M (SYSTEM) setting is set to "M" when setting the channels.
<ul style="list-style-type: none"> No picture appears or colour is not correct during playback. 	<ul style="list-style-type: none"> Make sure the TV is set to the same channel as the Product radio frequency converter output channel adjuster (CHANNEL). Check all connecting cables. Set the COLOUR MODE, NTSC MODE, and SYSTEM modes to match the tape and TV.



Problem	Suggested Solution
<ul style="list-style-type: none"> Cassette cannot be loaded. 	<ul style="list-style-type: none"> Make sure there is no other cassette inside. Make sure the cassette is correctly positioned and then reinsert.
<ul style="list-style-type: none"> Picture does not change even though CH ▲ / ▼ are pressed. 	<ul style="list-style-type: none"> Make sure the Product is not in the timer setting or clock setting mode.
<ul style="list-style-type: none"> Selected programme position does not appear. 	<ul style="list-style-type: none"> The channel may have been set to be skipped. Cancel the skip setting for that channel.
<ul style="list-style-type: none"> No colour appears during video search and the like. 	<ul style="list-style-type: none"> When a tape is recorded in the LP mode in the MESECAM system, the picture is discoloured during video search, still and similar modes. However, this does not indicate a malfunction.
<ul style="list-style-type: none"> Picture is skewed. 	<ul style="list-style-type: none"> If a tape is recorded in the LP mode (regardless of whether it is a MESECAM or PAL tape), the picture is skewed during video search. However, this does not indicate a malfunction.
<ul style="list-style-type: none"> NICAM sound cannot be output. 	<ul style="list-style-type: none"> Is NICAM set to OFF on the OSD mode?

■ DVD

Problem	Suggested Solution
<ul style="list-style-type: none"> The Product is switched on but does not operate. 	<ul style="list-style-type: none"> Have you loaded a disc? Is the disc unplayable? (See pages 3 – 5.) Is there dew in the Product? (See page 2.)
<ul style="list-style-type: none"> The playback image does not appear. No sound is produced. 	<ul style="list-style-type: none"> Are the video and audio cables connected correctly? (See pages 14 – 17.) Is the disc scratched? (See page 5.) Is the disc dirty? (See page 5.) Is the disc loaded upside down? Is the input selector on the TV set to “VIDEO” or “AV”? Is the audio equipment switched on and are all the components connected properly? (Refer to the operation manuals for your audio equipment.)
<ul style="list-style-type: none"> The sound is not Dolby Digital (5ch or 5.1ch). 	<ul style="list-style-type: none"> Is the disc you are playing recorded in Dolby Digital (5ch or 5.1ch)? Have you set the “ DIGITAL” in “AUDIO SETUP” to “BITSTREAM”? (See page 45.)
<ul style="list-style-type: none"> The image and sound are garbled. 	<ul style="list-style-type: none"> Is the disc scratched? (See page 5.) Are vibrations from the speakers affecting the Product?
<ul style="list-style-type: none"> The sound is not stable during playback. 	<ul style="list-style-type: none"> Set the “COMPRESSION” in “AUDIO SETUP” to “OFF” (See page 45.)

This Product is equipped with a microprocessor. Its performance could be adversely affected by external electrical noise or interference. If this should happen, unplug the Product and plug it in again after a few minutes.



Definition of Terms

■ VCR

Full Automatic Playback

This function automatically turns the power on and starts to playback when a tape with the erasure protection tabs removed is inserted.

Sharp Super Picture

Enhanced picture quality during playback.

S-VHS Simple Playback

This function facilitates S-VHS software playback. The original high picture quality of S-VHS (horizontal resolution of 400 lines) cannot be played.

Tracking Control

When noise appears on an image during tape playback, you can adjust the image quality to a suitable level so as to reduce the noise.

■ DVD

Angle

Recorded onto some DVD discs are scenes which have been simultaneously shot from a number of different angles (the same scene is shot from the front, from the left side, from the right side, etc.). With such discs, you can select the angle on Function Control Screen to view the scene from different angles.

Chapter Number

These numbers are recorded on DVD discs. A title is subdivided into many sections, each of which is numbered, and specific parts of video presentations can be searched quickly using these numbers.

Compression (Dolby Digital output level)

Setting that increases the average volume of Dolby Digital audio when playing a DVD.

Digital Gamma

Corrects for gradations in dark areas of images to make images clearer.

Dolby Digital (5.1 channel)

A sound system developed by Dolby Laboratories Inc. that gives movie theater ambience to audio output when the Product is connected to a Dolby Digital 5.1 channel processor or amplifier.

DTS

This is a digital sound system developed by Digital Theater Systems for use in cinemas. This system uses 6 audio channels and provides accurate sound field positioning and realistic acoustics. (By connecting a DTS Digital Surround decoder, you can also listen to DTS Digital Surround sound.)

CINEMA VOICE

For raising the sound of the center speaker to make the voices in a movie easier to hear.

3D Virtual Surround

For enjoying discs with a widespread surround sound feel.



DVD

This refers to a high-density optical disc on which high-quality pictures and sound have been recorded by means of digital signals. Incorporating a new video compression technology (MPEG II) and high-density recording technology, DVD enables esthetically pleasing full-motion video to be recorded over long periods of time (for instance, a whole movie can be recorded).

DVD has a structure consisting of two 0.6 mm thin discs which are adhered to each other. Since the thinner the disc, the higher the density at which the information can be recorded, a DVD disc has a greater capacity than a single 1.2 mm thick disc. Since the two thin discs are adhered to each other, there is the potential to achieve double-sided play sometime in the future for even longer duration play.

Letter Box

4:3 | LB

Screen size that cuts off the top and bottom of the image to allow playing of Wide (16:9) software on a connected 4:3 TV.

Linear PCM Sound

Linear PCM is a signal recording format used for audio CDs.

The sound on audio CDs is recorded at 44.1 kHz with 16 bits. (On DVD discs, sound is recorded at between 48 kHz with 16 bits and 96 kHz with 24 bits.)

Pan Scan

4:3 | PS

Screen size that cuts off the sides of the image to allow playing of Wide (16:9) software on a connected 4:3 TV.

Pickup

Laser device that reads the data from a disc for playback.

Playback Control (PBC)

This is recorded on a VIDEO CD (version 2.0). The scenes or information to be viewed (or listened to) can be selected interactively with the TV monitor by looking at the menu shown on the TV monitor.

Region

Number identifying a geographic region of compatibility for a DVD.

<Only for DV-NC70W, DV-NC70>

The list of the region number **3** countries

Common names	Names of Nations and Areas
Brunei Darussalam	Brunei Darussalam
Cambodia	Kingdom of Cambodia
Indonesia	Republic of Indonesia
Korea	Republic of Korea
Laos	Lao People's Democratic Republic
Malaysia	Malaysia
Myanmar	Union of Myanmar
Philippines	Republic of the Philippines
Singapore	Republic of Singapore
Thailand	Kingdom of Thailand
Viet Nam	Socialist Republic of Viet Nam
East Timor	East Timor
Hong Kong	*Hong Kong
Macau	*Macau
Taiwan	*Taiwan

*Represents area name



<Only for DV-NC70X>

The list of the region number 4 countries

Common names	Common names	Common names	Common names
Antigua and Barbuda	Guyana	Saint Vincent and the Grenadines	French Guiana
Argentina	Haiti	Samoa	French Polynesia
Australia	Honduras	Solomon Islands	Guadeloupe
Bahamas	Jamaica	Suriname	Guam
Barbados	Kiribati	Tonga	Martinique
Belize	Marshall Islands	Trinidad and Tobago	Montserrat
Bolivia	Mexico	Tuvalu	Netherlands Antilles
Brazil	Micronesia	Uruguay	New Caledonia
Chile	Nauru	Vanuatu	Niue
Colombia	New Zealand	Venezuela	Norfolk Island
Costa Rica	Nicaragua	Anguilla	Northern Mariana Islands
Cuba	Palau	Aruba	Pitcairn
Dominica	Panama	British Virgin Islands	Tokelau
Dominican Republic	Papua New Guinea	Cayman Islands	Turks and Caicos Islands
Ecuador	Paraguay	Christmas Island	Wallis and Futuna Islands
El Salvador	Peru	Cocos Islands	
Fiji	Saint Christopher and Nevis	Cook Islands	
Grenada	Saint Lucia	Falkland Islands	
Guatemala			

The world map for all region numbers

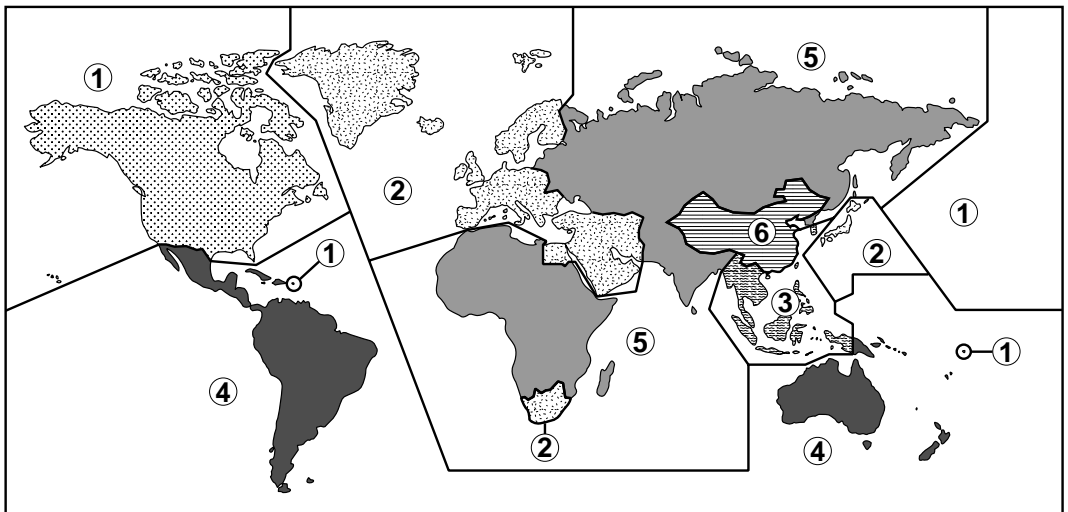

Subtitles

These are the printed lines appearing at the bottom of the screen which translate or transcribe the dialogue. They are recorded on DVD discs.

Time Number

This indicates the play time which has elapsed from the start of a disc or a title. It can be used to find a specific scene quickly. (It may not work with some discs.)

Title Menu

This is a menu displayed by some DVDs for selection of chapters and subtitle set. The title menu is also called a "top menu".

Title Number

These numbers are recorded on DVD discs. When a disc contains two or more movies, these movies are numbered as title 1, title 2, etc.

Track Number

These numbers are assigned to the tracks which are recorded on VIDEO CDs and audio CDs. They enable specific tracks to be located quickly.

VIDEO CD (VCD)

This contains recordings of pictures and sound whose quality is on a par with that of videotape. This Product also supports VIDEO CDs with playback control (version 2.0).

MP3

One type of audio compression that uses MPEG1. This format compresses sound to about 1/10, without impairing the original sound quality.



Specifications

	Signal System	NTSC/PAL
INPUT/OUTPUT JACKS	DVD/VCR shared output jacks	VIDEO jack: RCA Pin-jack AUDIO jack: RCA Pin-jack
	DVD output jacks	VIDEO jack: S-Video jack Component Y jack: RCA Pin-jack Component P _B jack: RCA Pin-jack Component P _R jack: RCA Pin-jack AUDIO jack: RCA Pin-jack DIGITAL AUDIO IF: Coaxial digital
	VIDEO input jacks	AUDIO output jack: RCA Pin-jack VIDEO jack: RCA Pin-jack AUDIO jack: RCA Pin-jack
VCR	Video recording system	Two rotary head helical scan system, VHS, Hi-Fi
	Video signal	PAL: PAL System-B/G, I, D/K, M (Playback/Recording) SECAM: MESECAM System B/G, D/K, K1 (Playback/Recording) NTSC: NTSC4.43 (Playback/Recording) NTSC: NTSC System M (NTSC 3.58) (Playback/Recording)
	Recording/playing time	720 minutes max. with E-240 tape (PAL) 480 minutes max. with T-160 tape (NTSC)
	Tape width	12.7mm
	Tape speed (PAL)	(SP) 23.39mm/sec (LP) 11.70mm/sec (EP) 7.80mm/sec
	(MESECAM)	(SP) 23.39mm/sec (LP) 11.70mm/sec
	(NTSC)	(SP) 33.35mm/sec (LP) 16.67mm/sec (Playback only) (EP) 11.12mm/sec
Antenna Receiving channel	75 ohm unbalanced VHF: 1A-E12 (C1-C12), UHF: E21-E69 (C13-C57), European CATV: S1-S41 VHF: US AIR 2-13, UHF: US AIR 14-79, CATV: 2 to W+84 VHF: JAPAN 1-12, UHF: JAPAN 13-62 VHF: AU 0-13, UHF: AU 28-69 [DV-NC70X only]] [DV-NC70W/70 only]
NICAM format	NICAM-I, B/G, D/K	
IGR stereo format	IGR-B/G, D/K	
RF converter output signal	E21-E69 (adjustable), US AIR 26-38 (adjustable), JAPAN 25-37 (adjustable). [DV-NC70W/70 only] AU 28 - AU69 (adjustable). [DV-NC70X only]	
DVD	DVD/VCR shared Video output	Output level: 1 Vp-p (75Ω)
	Component color output	Y output level: 1 Vp-p (75Ω) P _B output level: 0.525 Vp-p (75Ω)/75% color P _R output level: 0.525 Vp-p (75Ω)/75% color
	S video output	Y output level: 1 Vp-p (75Ω) C output level: 0.3 Vp-p (75Ω)
	Audio output	Output level: 2 Vrms (1 kHz, 0 dB)
	Video signal horizontal resolution	500 lines
	S/N ratio	60 dB
	Audio signal frequency characteristics	For DVD linear PCM playback: 4 Hz to 22 kHz (48 kHz sampling) 4 Hz to 44 kHz (96 kHz sampling) CD playback: 4 Hz to 20 kHz (JEITA)
	S/N ratio	CD: 96 dB, 1 kHz (JEITA)
	Dynamic range	DVD linear PCM: 96 dB (JEITA) CD: 96 dB (JEITA)
	Total harmonic distortion ratio	CD: 0.006% (JEITA)
Pickup	Wave length: 650 nm (DVD) / 780nm (CD) Laser output: Max. 0.7 mW	
Operating temperature	5°C to 35°C	
Storage temperature	-20°C to 55°C	
Power supply	110 V to 240 V AC, 50/60 Hz [DV-NC70W/70 only] 240 V AC, 50 Hz [DV-NC70X only]	
Power consumption	23 W	
Dimensions	430 mm × 93.5 mm × 356 mm (W × H × D)	
Weight	4.8 kg	

Specifications are subject to change without notice.

Weight and dimensions are approximate.

Memo

SHARP CORPORATION

Osaka, Japan